



UFE Series Single

Application Note 212



1. Introduction	2
2. Models	
Features	2
3. General Description	
Electrical Description	3
Efficiency	3
4. Features and Functions	
Automatic Line Operation Level Selection	4
Front Panel LED	4
Input Filter	5
Inrush Current Control	5
Input Line Voltage Monitoring	5
Operatingtemperature Range	6
Overtemperature Protection (OT)	6
Output Overvoltage Protection (OV)	6
Main Output ORing FETs	6
Power Limit	6
Intelligent Current Limit (OC)	6
Automatic Synchronizing Start-Up	6
Current Sharing	6
Floating Output Polarity	7
Hold-Up	7
Turn-On Delay	7
Remote ON/OFF	7
Remote Sense	7
Auxiliary Output	7
Serial Communications Interface	7
Serial Communications Interrupt Signal	7
Serial Communications Addressing Pins	7
Serial Communications Enable Signal	7
DC Output Status Signal	7
UFE System Presence Signal	7
The Short Pin	7
Internal Cooling Fans	7
5. Safety	
Isolation	8
Input Fusing	8
6. EMC	8
7. Applications	
Optimum Thermal Performance	9
Signal Ground	9
Output Ripple and Noise Measurement	10

1. Introduction

This application note describes the features and functions of Artesyn Technologies' UFE series of front-end power supplies. The UFE series is designed to draw wide range input power from 88 Vac to 276 Vac and provide flexible (variable), isolated, floating, power-limited output in two configurations, 24 V and 48 V. Each configuration provides an auxiliary output of 11 V at 250 mA. The UFE series also includes automatic-regulating fans for self-cooling. Automatic regulation of the cooling fans mean getting the quietest possible operation while at the same time maximizing fan life. The UFE series is designed for operation over a wide temperature range, from -33 °C to + 70 °C. All UFE models are fully protected against output overvoltage, output overcurrent, output undervoltage, and overtemperature. Standard features include remote ON/OFF and I²C serial communications OR PMBus serial communications for control and monitoring.

2. Models

The UFE series consists of 4 models, listed in Table 1.

The series is intended for use in the telecommunications applications and complies with the following standards:

- ESD Air/Contact: EN61000-4-2; severity level 3
- Surge: EN61000-4-5; severity level 3
- Fast Transients: EN61000-4-4; severity level 3
- Flicker: EN61000-3-3
- Radiated Immunity: EN61000-4-3; severity level 3
- Conducted Immunity: EN61000-4-6; severity level 3
- Voltage Dips and Sags: EN61000-4-11
- Conducted EMI: EN55022 Class B

RATED OUTPUT POWER	OUTPUT VOLTAGE VOUT (MIN)	OUTPUT VOLTAGE VOUT (MAX)	OUTPUT CURRENT (MIN.)	POWER LIMIT +15%/-0% ≥VOUT (MIN)	LINE RANGE AT TURN ON (AUTO RANGING)	OPERATING LINE RANGE	CURRENT LIMIT (VOUT) < VOUT (MIN)	MODEL NUMBER
I²C Serial Communications Type								
1300 W	42 V	57 V	0 A	1300 W	88-140 Vac	88-264 Vac	33 A	UFE2000-96S48CJ
2000 W	42 V	57 V	0 A	2000 W	150-264 Vac	176-264 Vac	52 A	
1300 W	21 V	28.5 V	0 A	1300 W	88-264 Vac	88-264 Vac	65 A	UFE1300-96S24CJ
PMBus Serial Communications Type								
1300 W	42 V	57 V	0 A	1300 W	88-140 Vac	88-264 Vac	33 A	UFE2000-96S48PJ
2000 W	42 V	57 V	0 A	2000 W	150-264 Vac	176-264 Vac	52 A	
1300 W	21 V	28.5 V	0 A	1300 W	88-264 Vac	88-264 Vac	65 A	UFE1300-96S24PJ

Table 1 - UFE Series Models

RoHS Compliance Ordering Information



The 'J' at the end of the part number indicates that the part is Pb-free (RoHS 6/6 compliant). TSE RoHS 5/6 (non Pb-free) compliant versions may be available on special request, please contact your local sales representative for details.

Features

- Auto ranging input – limits the output power based on line voltage at turn on.
- Self contained cooling with linear fan speed control for extended fan life and quiet operation.
- Auxiliary voltage at 11 V +/- 15%, 2.875 W.
- Adjustable output voltage by serial communications, 10-bit resolution.
- Output voltage droop or active current sharing, selected by serial communications.

- Remote ON/OFF by discrete signal or serial communications.
- Output or-ing FET's, functionally verified by serial communications.
- Serial communications watch dog timer, selectable.
- Default turn on configuration can be changed by serial communications.
- User accessible EEPROM – up to 175 bytes available in standard model, 431 bytes available with optional EEPROM.
- Floating and isolated output voltage allows positive or negative polarity operation.
- Power limit.
- Brick wall, pulsating Current Limit – 0.200 s on/1.80 s off repeat – limits damaging current levels duration.
- Automatic start up synchronization for parallel operation.
- 20 ms hold up.
- Fault code front plate LED – allows quick visual assessment of status.
- High power density, > 22 W/in3
- High efficiency topology, typically 89% at full load, up to 91%.
- Compatible with Artesyn Lead-Free and RoHS roadmaps.
- No minimum load requirement.
- Fixed switching frequency.
- Overtemperature protection (OTP).
- Input under/overvoltage lockout protection (UVLO/OVLO).

*PMBus™ is a trade mark of the System Management Interface Forum, Inc.

3. General Description

3.1 Electrical Description

A block diagram of the UFE series is shown in Figure 1. Improved levels of efficiency are achieved by the use of ORing FETs instead of diodes.

AC-DC conversion is achieved with a PFC continuous mode boost front-end and interleaved two-switch forward topology. Power is transferred magnetically across the isolation barrier via isolating power transformers. All models have specialized control circuitry for ORing FET control. The functionality and health of these ORing FETs can be tested via serial communications.

The main power output of a UFE series supply is adjustable via serial communications. The adjustment range is 42 V to 57 V for the UFE2000 models, and 21 V to 28.5 V for the UFE1300 models. The adjustment resolution is 10-bit and accuracy over all operating conditions is 0.5%. The main power output of a UFE series supply can also operate with droop mode current sharing or active mode current sharing. This output is also floating, which means that the output can be either positive or negative polarity. This output also includes a full 20 ms hold-up, stand alone.

The UFE series includes an auxiliary output at 11 V +/- 15% at 250 mA. This output can be used for many different purposes and is capable of being paralleled with other UFE auxiliary outputs. Many primary and secondary operating and performance parameters can be monitored or adjusted via the serial communications interface. The two options available for serial communications are I²C or PMBus™. Full details are available in the respective application notes.

The UFE series is fitted with internal cooling fans as well as internal EMI filtering. The cooling fans provide maximum life by regulating speed as necessary to meet cooling requirements. These fans are fully capable of providing all of the cooling needs of the UFE series up to 70 °C. The UFE series also self-protects against thermally related damage by disabling power conversion if internal temperatures get above the safe operating level. Recovery is automatic when temperatures have returned to safe operating level again.

The UFE series is fitted with internal EMI filtering. This filter is capable of enabling the UFE series to pass Class B limits for conducted emissions and when combined with the recommended external components, Class B radiated emissions can be achieved.

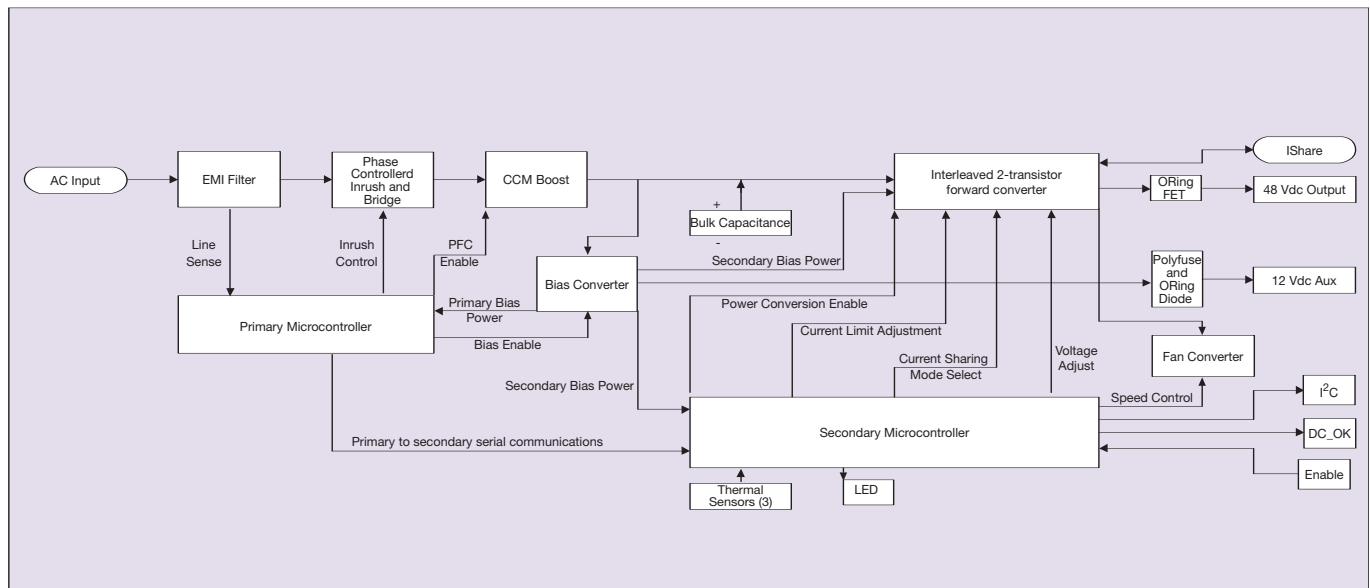

Figure 1 - UFE Series Converter Block Diagram

3.2 Efficiency

The efficiency of the UFE series supply will vary over the complete range of operating conditions. Figure 2 illustrates some typical efficiency curves under varying conditions for a UFE2000 series supply. Please note that at 110 Vac the power limit is reduced to 1300 W.

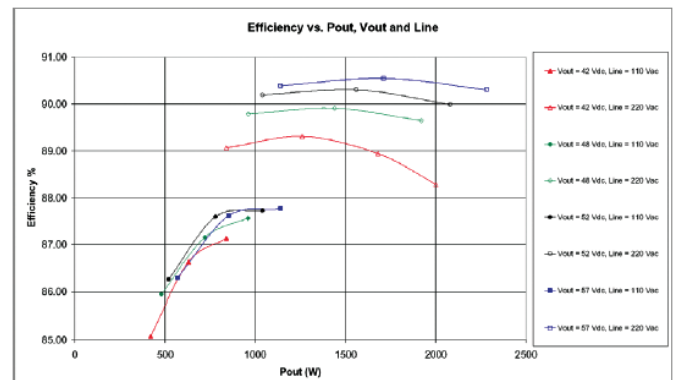

Figure 2 - Typical UFE2000 Efficiency Curves

4. Features and Functions

4.1 Automatic Line Operation Level Selection

The UFE series will automatically select an appropriate output power limit point based on line voltage at first power up. The Primary side microprocessor measures the line voltage 150 ms after line voltage is present and then makes the selection of whether the operation will be wide line (WL, 88 V to 264 V) or high line only (HL, 176 V to 264 V). If the line voltage reading is below 140 V at the time of this measurement, the operation of the supply will behave accordingly and limit the output power of the supply as necessary. Line voltage must be over 150 V to guarantee high line operation only. Full power from the UFE2000 series can only be achieved with high line selection and operation. This line selection decision is made each time the UFE series supply powers up initially. While the front panel LED is illuminated, this decision is permanent and can only be re-determined after the LED goes out.

4.2 Front Panel LED

The single tri-color LED on the front panel of a UFE supply is used for many purposes. This LED has the capability to relay information about the status of the supply by a specialized blink code. If everything is OK and power conversion is active, this LED is green. If this LED is solid amber, then power conversion is not active. For details on the blink codes refer to Table 2.















LED BEHAVIOUR		CAUSE
*NOTE, BLINK RATE IS 250 ms PER COLOUR OR OFF STATE		
Steady green		Power conversion is active all parameters normal
*Blinking green/off		I ² C watchdog timer has timed out (No messages for 45 s. If watch dog is enabled, watch dog is default off)
*Blinking amber/green steady current limit is 200 ms green, 1.8 s amber		The unit is in pulsating current limit, 200 ms enabled, 1.8 s disabled
*Blinking amber/green		The ac line is low and power conversion will cease if voltage goes any lower. (1.5 s repeat)
*Blinking amber/green		Thermal unit warning, unit may shut down soon (2 s repeat)
*Blinking amber/green		Thermal ambient warning, unit may shut down soon (2.5 s repeat)
*Blinking amber/green		12 V-Aux is below 10 V or above 14 V (3 s repeat)
*Blinking amber/green		The fan converter is bad and is putting out too little or too much voltage for the fans (3.5 s repeat)
Steady amber		Power conversion is disabled for any reason except OT or OV
*Blinking amber/off		Thermal fault (OT), unit will turn off until cool enough to turn back on
*Blinking amber/off		Overvoltage (OV), the unit is latched off due to an OV condition on it's output (1.5s repeat)
*Blinking amber/red		Output OR-ing FET test failed
Steady red		PFC is bad, unit will be turning off very soon
*Blinking red/off		Line is above 285 Vrms ±3% (416 V peak). Unit will not shut down because of this, but will not turn on if true

Table 2 - Front Panel LED Details

4.3 Input Filter

The UFE series of power supplies is designed to pass stand-alone class B conducted emissions. System design can enhance or degrade this performance. It is recommended to add the suggested components and follow the suggested guidelines in Section 6 to help increase successful implementation with desired conducted as well as radiated performance.

4.4 Inrush Current Control

Inrush current is controlled with the primary side microcontroller and two SCR's. The SCR's form part of the full wave line voltage rectifier. At start up, the SCR's are gradually phased on until they are enabled at the peak of the AC line. Subsequently, they are commanded on all of the time and act like standard rectifier diodes. At that point, the PFC boost circuit is enabled and the bulk capacitors are charged the rest of the way to 400 V using the soft start of the PFC boost controller. The boost soft start results in a peak inrush current of 55 A maximum, for one line cycle. Figures 3 and 4 illustrate the typical inrush process stages.

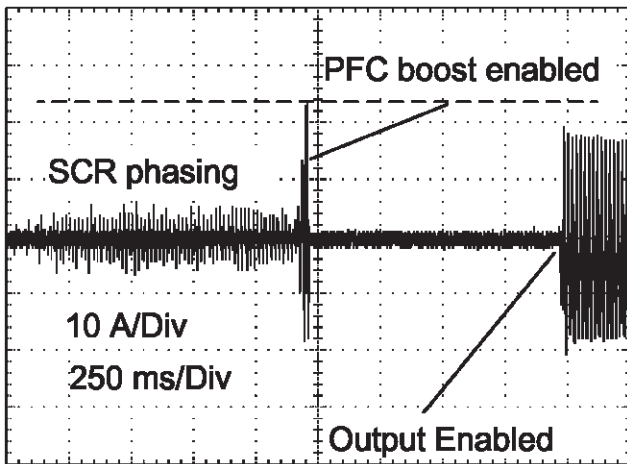

Figure 3- Typical Stages of the Inrush Process.

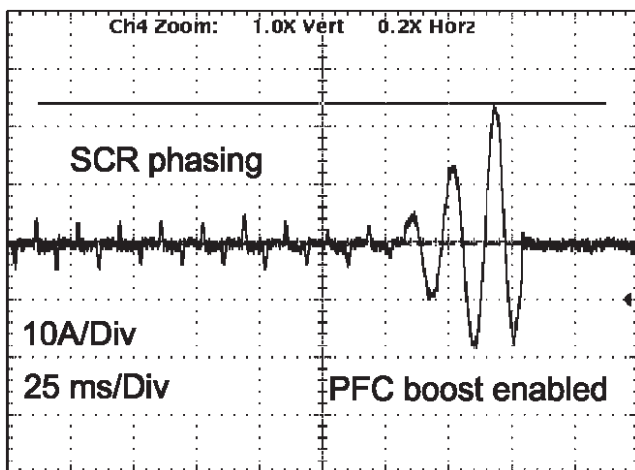

Figure 4 - Zoom In of the End of a Typical Inrush Process

Note that there is also approximately 3.2 μF of internal EMI filter X-capacitance placed in front of the line rectifying SCR's. The 1.0 A \cdot s rating in the general specification is intended to apply to the charging of this capacitance. Figure 5 illustrates an example input current waveform due to the initial AC power application to the X-capacitors before the inrush process begins. The test setup that produced this example waveform consisted of Elgar equipment model numbers SW 5250M, SW 5250S, and SW PDU and 200 inches of 12 AWG cabling from the output of the Elgar to the input of the UFE power supply. Input voltage was set to 264 Vrms, and power was applied at the peak of the sine wave. With this setup, the measured I \cdot C was about 0.082 A \cdot s, with a peak amplitude of 82.4 A and a duration of 70.4 μs .

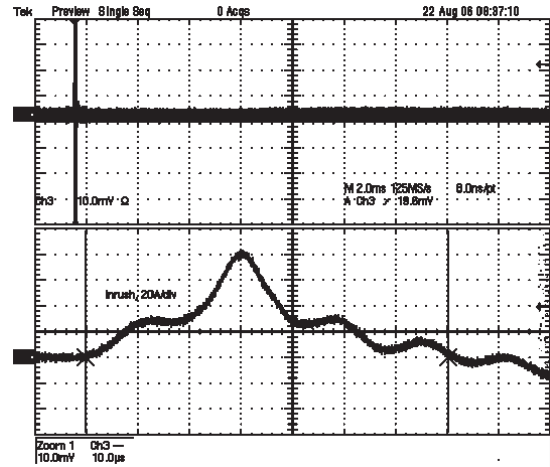

Figure 5 - Input Current Before the Inrush Process at Power Application Due to EMI Filter X-Capacitance

4.5 Input Line Voltage Monitoring

The AC line input to the UFE series supply is closely monitored by the primary side microcontroller. If the line voltage is above 285 Vrms $\pm 3\%$ at start-up, the UFE series converter will not enable power conversion. A blinking red front panel LED will display this. Status of this can also be obtained over serial communications. This does not mean that voltages higher than 285 Vrms can't damage the UFE series. The first part to fail will be the line to line MOV. The voltage that the part can handle is temperature related because it depends on the part dissipation as it starts to leak at higher input voltages than specified. The component specification states that the part can handle 276 Vrms continuous at 85 $^{\circ}\text{C}$. More if the temperature is lower. Beyond that the input voltage will eventually cause the bulk capacitors to peak charge. By 318 Vrms, the bulk capacitors can be peak charged to their rating of 450 Vdc, but before that happens there will be significant line current distortion near the peak of the AC line waveform.

If the line voltage is below 180 V (HL operation) or 90 V (WL operation) the unit will warn of the low line condition by LED (section 4.2) and serial communications, but power conversion will continue down to the undervoltage lockout (power down) voltage specified.

4.6 Operating Temperature Range

The UFE series is designed to operate from $-33\text{ }^{\circ}\text{C}$ to $+55\text{ }^{\circ}\text{C}$, with an extended operating range from $-40\text{ }^{\circ}\text{C}$ to $70\text{ }^{\circ}\text{C}$. Some derating requirements must be met, depending on output voltage, above $55\text{ }^{\circ}\text{C}$. See Section 7.1 for details. When the turn on temperature is below $-15\text{ }^{\circ}\text{C}$ the supply will enter a cold start mode of operation. While in the cold start mode of operation, the output voltage is limited to 48 V or below for the UFE2000 models, and 24 V or below for the UFE1300 models. On the UFE2000 models, the power limit point will be forced to 1300 W. The discrete DC-OK-L will also be high (+5.0V) to indicate that it is not OK to load the supply fully. After the internal circuitry has reached an acceptable level for full function within specifications, the cold start mode will end and power conversion will return to normal start-up default. The discrete DC-OK-L will also go low (0 V) at this point, indicating that the output of the supply is ready for loading. The time that cold start mode is enabled at start up depends on initial loading. The more the loading the quicker the unit will get out of the cold start mode. The maximum amount of time a unit will spend in cold start is limited to 15 minutes by an internal timer.

4.7 Overtemperature Protection (OT)

There are three internal sensors inside each UFE supply. One sensor monitors the internal ambient temperature, and two sensors monitor the two hottest internal heat sinks. If any one of these three sensors exceeds the pre-determined limit power conversion will cease for the main UFE output, not the auxiliary output. Because the fans are powered from the main output, they will turn off as well. Power conversion will remain disabled until temperatures reach an acceptably safe level again. Restoration of power conversion is automatic.

4.8 Output Overvoltage Protection (OV)

Overvoltage is controlled by both hardware and software in the UFE series of supplies. The hardware OV trip is set to 63 V on the UFE2000 models and 31.5 V on the UFE1300 models. The software OV trip point is set to 60 V on the UFE2000 models and 30 V on the UFE1300 models. The hardware OV trip is immediate, while the software OV trip has a 100 ms timer before engaging power conversion shutdown. This is done to ensure SELV protection.

The OV power conversion shutdown is latching after 1 retry. An OV condition will cause power conversion to cease. After 4 seconds, power conversion will resume. If the OV condition is still present, power conversion will cease until the UFE is reset by either toggling the discrete enable pin, toggling input power, or toggling enable by serial communications. If the OV condition is not still present after the 4 seconds, power conversion will continue normally. Ten seconds after the first OV condition, the retry process is reset and the UFE will attempt another retry after 4 seconds if an OV occurs again.

4.9 Main Output ORing FETs

To gain better efficiency, the use of ORing FETs has been implemented. The ORing FET control circuitry is designed to provide reverse current protection in a minimum amount of time for supply protection. The functionality and health of this circuitry can be tested in a 2N redundant system via serial communications interface. In a redundant system, the ORing FET test disables power conversion for 1 second. If the ORing FETs are functioning properly, they will be disabled and the UFE supply will begin regulating its internal voltage before the ORing FET at a slightly lower voltage than the common output bus. If this is not the case, then the ORing FET is not functioning properly. The results of the test are available via serial communications as well as by the red/amber blinking LED on the front cover.

4.10 Power Limit

The UFE series of power supplies incorporate the use of power limit, in addition to current limit. The output power of a UFE supply will provide at least the rated power, and up to 115% of the rated output power at any voltage setting. What this means is that the output of the supply will make adjustments as necessary to the output in order to provide the power the load is demanding. If the load is 40 A, for a 2000 W UFE, then the possible output voltage can drop as low as 50 V. If the load is 45 V, then the output current can go at least as high as 44.5 A without engaging current limit.

4.11 Intelligent Current Limit (OC)

Current limiting is controlled by both hardware and software in the UFE series. The hardware is very fast and controls the output of the supply directly. The software is capable of observing that the unit is in a current limit condition and can disable power conversion to limit the energy delivered. In order for power conversion to be disabled, the output voltage of the supply must drop below a UV threshold. For a UFE 2000 I²C model, this UV threshold is 41 V. For a UFE 2000 PMBus™ model, the default threshold is 41 V but is variable down to 15 V. For the UFE 1300 models, this default threshold is 20 V.

Once this UV threshold is exceeded, and the current limit hardware indicates an active current limit condition, power conversion will continue providing maximum current for only 200 ms. After this delay, and the condition is still true, power conversion will be disabled for *up to 1.8 s. Then the process repeats until the UV or OC condition is removed. See Section 4.12.

4.12 Automatic Synchronizing Start-Up

It may be possible under certain conditions that multiple, paralleled UFE's be required at the time of start up to power large loads. It may also be possible that a single UFE not be able to power the system load at power up by itself. Due to these possibilities, the UFE series supplies are capable of detecting the output voltage of other paralleled supplies. If one UFE happens to power up faster than others in a paralleled system, and can't provide 100% of the output power, it will enter into smart current limiting cycle. As soon as another UFE enables power conversion, the first UFE will see that and cut off the 1.8 s off timer and enable its output right away. This will synchronize the two units. If two supplies aren't enough to power the system load, they will repeat current limiting on a synchronized cycle, until another unit is inserted into the system.

4.13 Current Sharing

Two modes of current sharing are available, active and droop. Droop mode current sharing simply requires that the outputs of multiple UFE supplies be tied together. The down side to this mode of operation is that the output voltage varies by load, the higher the load, the lower the voltage. The slope of this variance is 80.6 mV/A +/- 3% from 10 A to power limit for the UFE2000 models, and 40.3 mV/A +/- 3% for the UFE1300 models.

Active current sharing doesn't exhibit this droop behavior, however it's use requires the tying together of the discrete Ishare control pin between all paralleled UFE supplies. Active current sharing mode is also the only mode where an adjustment to output voltage can be predicted accurately because of the independence from loading on voltage.

Active mode current sharing is the factory default mode for the UFE1300 models, and droop mode is the factory default for the UFE2000 models. The selection of which mode to use is made via serial communications, and the default mode can be changed. The accuracy of both modes of current sharing is 15% max defined by Equation 1.

$$(I_{\text{unit1}} - I_{\text{unit2}})/I_{\text{limit}} \bullet 100$$

Equation 1 - Current Sharing Accuracy calculation

The difference of output current between any two supplies operating in parallel does not exceed 15% of the rated current limit, from 0 A load to 110% of maximum load.

4.14 Floating Output Polarity

The main power output of a UFE series supply is floating, which means that the polarity can either be positive or negative with respect to signal ground. All control circuitry is referenced to signal ground.

4.15 Hold-Up

The UFE series includes a full 20 ms of hold-up time on the main power output. The hold-up time is defined down to 45 V on the UFE2000 series and down to 24 V on the UFE1300 series.

4.16 Turn-On Delay

Due to inrush control and programmed internal delays, it can take up to 5 seconds from the time line voltage is present to the time output power conversion is enabled and within regulation.

4.17 Remote ON/OFF

The main output can also be disabled and enabled via serial communications and/or discrete signal pin. The discrete signal pin is referred to as PS-EN for the I²C models and CONTROL for the PMBus™ models. For the I²C models, the polarity is fixed and the power supply will enable power conversion when this pin is pulled to signal ground. For the PMBus™ models, the polarity of this pin is default active low and its use is required. However, over the PMBus™ it is possible to change the polarity of this pin as well as require it's use or not. See the respective application notes for further details.

4.18 Remote Sense

Remote sense is provided to compensate for distribution losses of up to 0.5 V. It is not necessary but it is recommended that these lines be connected at a common load point between paralleled UFE's for best current share performance.

4.19 Auxiliary Output

The UFE series includes an auxiliary output at 11 V +/- 15% at 250 mA. ORing all paralleled auxiliary outputs together can achieve control circuit bias power redundancy. This can provide a means of serial communication to a non-responsive power conversion, paralleled UFE in a system, for purposes of interrogation if possible.

4.20 Serial Communications Interface

Two possible serial communications are provided, I²C or PMBus™. Although the default settings are designed so that no serial interface is required for operation, in order to get all available functionality from the UFE series. Please refer to respective application notes for details.

4.21 Serial Communications Interrupt Signal

The PMBus™ serial communications interface uses the SMBALERT# signal pin for alerting the host as necessary. Details are in the PMBus™ application note as well as the PMBus™ specification.

4.22 Serial Communications Addressing Pins

The discrete pins [PS-ID3:PS-ID0] are used to set up a UFE's address on the serial bus. Complete details are provided in the Application Notes 210 and 211.

4.23 Serial Communications Enable Signal

As a troubleshooting aid, the UFE series has included a serial communications enable signal. This signal is referred to as I²C-En-H for the I²C model UFE's, and Comm-En-H for the PMBus™ model UFE's. This signal is pulled up to +5.0 V internally so that serial communications is default enabled. If UFE serial communications is suspected of locking the serial bus, this signal can be driven low (0.0 V) to cause a serial communications hardware reset. While this signal is low, the serial communications hardware is isolated by FETs from the bus.

4.24 DC Output Status Signal

The DC-OK-L signal provides indication that power conversion on the main power output is enabled and within specification limits. If this signal is low then power can be supplied by the UFE. If the signal is high, then there may be something wrong or the supply is waiting before pulling the signal low. Serial communications can be used for inquiry into why the signal is high.

4.25 UFE System Presence Signal

The Present-L signal simply provides indication that a UFE has been inserted into the system. When a UFE is inserted into a system, this signal pin will be at signal ground, capable of pulling low a signal that may present.

4.26 The Short Pin

For purposes of hot plugging, a short pin is provided. This pin is the last to mate and the first to break electrical connection. This pin is directly tied to the secondary microcontroller. In order for power conversion to proceed, this pin MUST be tied to signal ground on the mating system connector.

4.27 Internal Cooling Fans

Two internal cooling fans are installed in each UFE series power supply. These fans are capable of sufficiently cooling the UFE supply up to ambient temperatures of 55 °C over all operating conditions above 48/24 V output voltages. Some derating is required from 55 °C to 70 °C as well as below 48/24 V output voltages. In order to maximize cooling efficiency, minimal backpressure should be imposed on each UFE in the system. In order to maximize system efficiency and fan life, as well as minimize acoustical noise, fan speed is adjusted as necessary to meet the cooling needs of the supply. As conditions such as ambient temperature and load change so does the fan speed. Care must be taken to ensure that the fan inlets (front) and fan outlets (rear) are not obstructed. Obstructed fan inlets and outlets can cause inadequate cooling capacity and thermal shutdown of the unit.

The fan drive circuitry is capable of linearly driving the fan voltage from 6 V to 12 V. At system start up, the fan drive is set to 9 V to ensure proper start up of the fans. As soon as the fans start up, the control loop will take over and adjust the speed as necessary in order to cool the supply properly. With the maximum rated load at 20 °C ambient, the fans will operate at 6 V, which typically produces 56 dB acoustical noise. At 55 °C ambient and maximum rated load the fans will operate at 12 V and typically produce 69 dB acoustical noise. Figure 6 illustrates the typical fan characteristics over ambient temperature ranges at full rated output power. The test setup to gather the fan noise readings consisted of a Simpson model 886 type 2 sound level meter positioned 1 meter in front of and 1 meter above the intake of the power supply on a table in the middle of a quiet room.

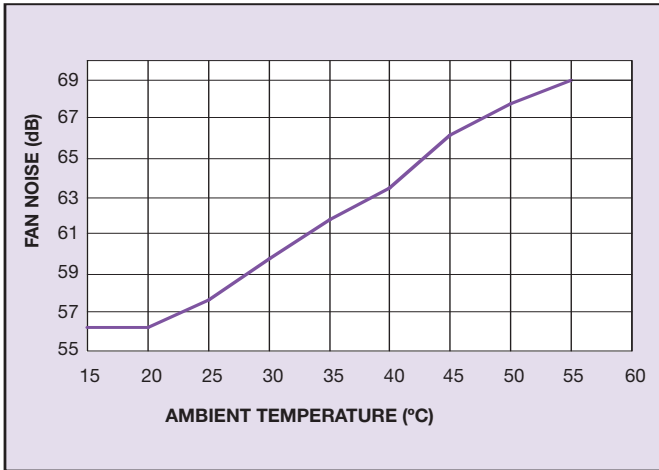

Figure 6 - Typical Fan Noise Vs Ambient Temperature at Full Rated Load

5. Safety

5.1 Isolation

The UFE series of power supplies have been designed in accordance with 60950-1 safety standards.

The UFE series of power supplies is intended for inclusion in other equipment and the installer must insure that it is in compliance with all the requirements of the end application.

The galvanic isolation is verified in an electric strength test during production, with the test voltage between input and output and input to chassis being 2,121 Vdc. The dielectric strength of the isolation is 2,510 Vdc from input to chassis, and 4,242 Vdc from input to output.

5.2 Input Fusing

Both AC lines of the UFE are independently fused internally.

6. EMC

In order to meet the radiated class A or class B limits of EN55022, external filtering of the AC input power is required. In addition, if the output power leads will be exposed outside of the system chassis, or routed nearby the filtered AC input leads; it may also be necessary to filter the output power leads.

Figure 7 shows an appropriate external AC line filter that allows the UFE to meet class B radiated EMI, as well as substantially improve the conducted emissions. On the AC line side of the filter, small Y capacitors in the range of 100 to 470 pF are added from each line to chassis. In addition, a 1uF X capacitor is added between line 1 and line2. A common mode choke consisting of 8T:8T on opposite sides of a steward 28B1142-100 or equivalent core is used. On the UFE side of the filter, two larger Y capacitors of 4700pF from each line to chassis are included. No X capacitor is necessary on the UFE side of the filter.

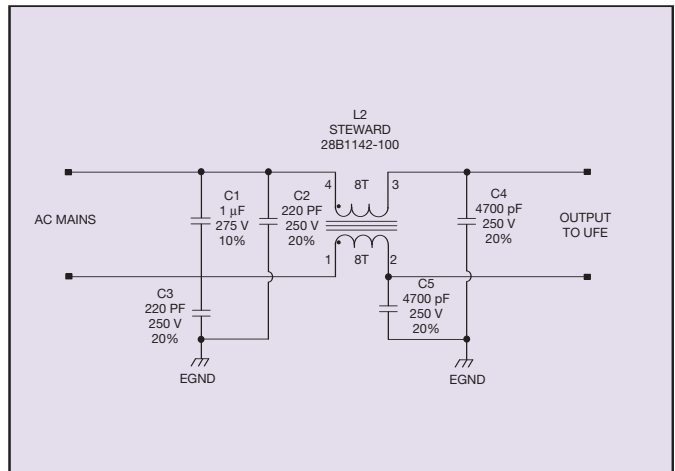

Figure 7 - The Recommended External AC filter Can Be Used To Meet EN55022 Class B Radiated Emissions.

Figure 8 shows an appropriate external DC output filter needed to bring the output leads into compliance with EN55022 class B radiated emission limits. The DC output filter uses a 1T:1T common choke on a Steward 28R0880-000 or equivalent core. On both sides of the choke are four 0.47µF/100V 1206 X7R ceramic capacitors: 1 each from out+ and out- to chassis, and 2 between out+ and out-.

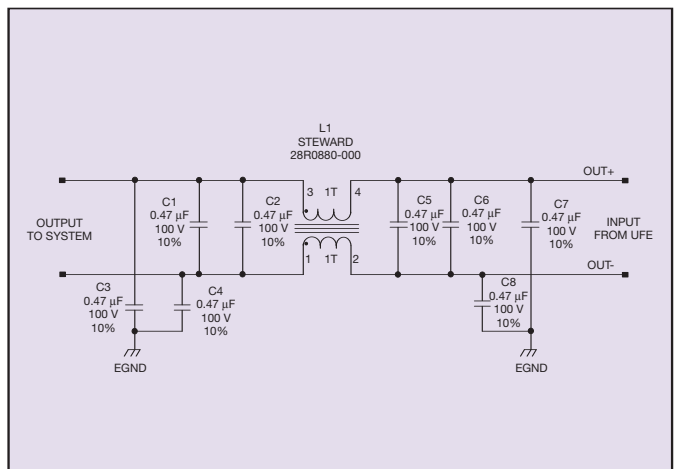

Figure 8 - The Recommended External DC filter Can Be Used To Meet EN55022 Class B Radiated Emissions.

For best filter performance, the AC input filter should be located away from the power supply and close to the power entry of the system chassis. If the filter must be located immediately behind the UFE, a shield wall that covers the UFE I/O connector is recommended. In addition, both AC and DC filters should be used. The shield wall must be mounted between the UFE connector and the external filters with the shield wall tied through the connector/filter circuit board to standoffs below the circuit board that connect the circuit board to the bottom system chassis floor. There should be 4 standoffs in a line parallel to the long dimension of the connector, spaced on approximately 1" centers. The shield wall should be approximately as wide as the UFE, and must bend over the UFE connector to attach with beryllium copper fingers (or equivalent) to the top chassis surface of the UFE. Because the shield wall is in the UFE airflow, it should be made from stamped sheet metal with a wide hole pattern (approximately 0.3" square openings).

7. Applications

7.1 Optimum Thermal Performance

The electrical operating conditions of the UFE series of power supplies, namely:

- Input voltage, V_{in}
- Output voltage, V_o
- Output current, I_o

determine how much power is dissipated within the converter. The following parameters further influence the thermal performance and self-cooling capability of the UFE supply:

- Ambient Temperature
- Airflow Backpressure
- Altitude

In order to simplify system design capability, derating plots are given in Figures 9, 10 and 11. These figures show output power capability as a function of ambient temperature for different output voltage levels at low line conditions.

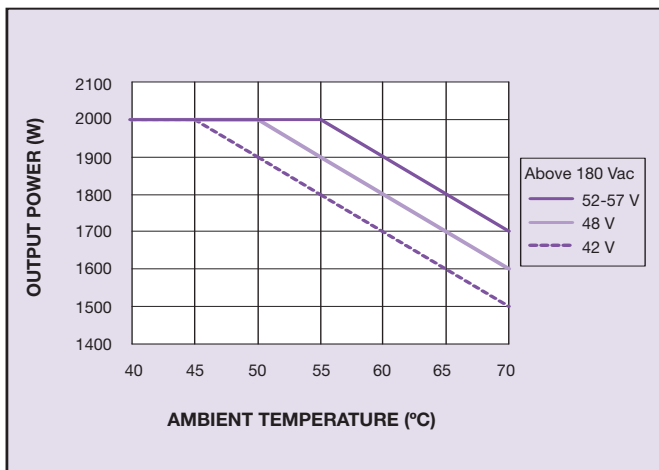

Figure 9 - Thermal Derating Curve for UFE2000-96S48 Model High Line Input Voltage

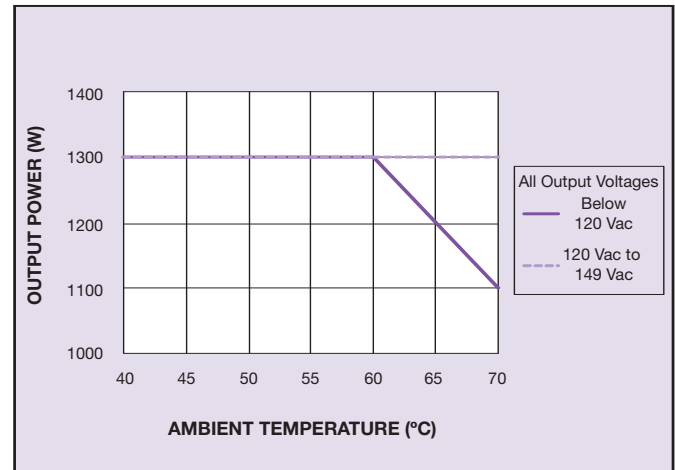

Figure 10 - Thermal Derating Curve for UFE2000-96S48 Model Low Line Input Voltage

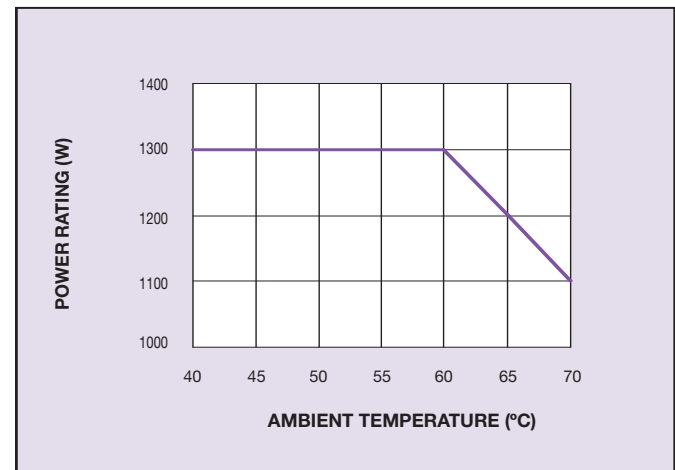

Figure 11 - Thermal Derating Curve for UFE1300-96S24 Model All Conditions

Also, for operation above 1,524 m (5,000 ft) maximum operation temperature is derated by 2 °C per 305 m (1,000 ft)

7.2 Signal Ground

All discrete signals, input and outputs, including serial communications, are referenced to signal ground. Signal ground needs to be tied directly to either side (+ OR -) of the main output in order to function correctly.

7.3 Output Ripple and Noise Measurement

The measurement set-up outlined in Figure 12 has been used for both output ripple and noise measurements for the UFE series of power supplies. When measuring output ripple and noise, a scope jack in parallel with a 0.1 μF ceramic chip capacitor, and a 10 μF aluminum electrolytic capacitor should be used.

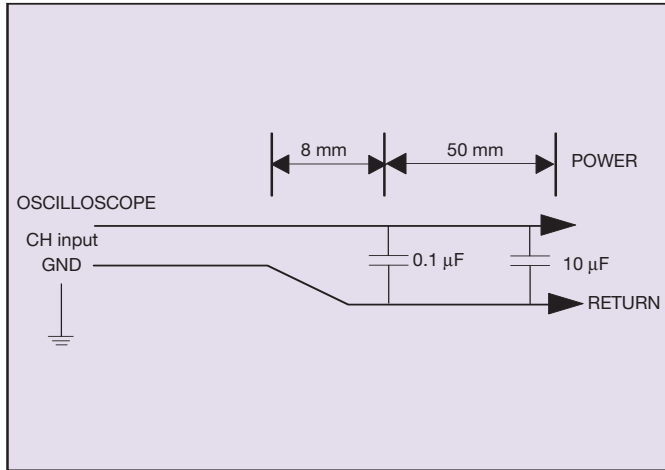

Figure 12 - Output Voltage Ripple and Noise Measurement Set-Up

Application Note © Artesyn Technologies® 2006

The information and specifications contained in this application note are believed to be correct at time of publication. However, Artesyn Technologies accepts no responsibility for consequences arising from printing errors or inaccuracies. The information and specifications contained or described herein are subject to change in any manner at any time without notice. No rights under any patent accompany the sale of any such product(s) or information contained herein.