

ARTESYN INTELLIGENT TRANSFER SWITCH

Up to 24000 Watts



Designed for any application needing power switched to different loads during a 24 hour period (i.e. Horticulture, Burn-in, Test and Measurement, etc.) Advanced Energy's Intelligent Transfer Switch has a built-in PSU to supply power to the relays and MCU module. It is designed to operate with 90 to 264 VAC standard phase input.

AT A GLANCE

Total Power

Up to 24 KW

Input Voltage

90 to 264 VAC
Single Phase

of Outputs

Up to 8

SPECIAL FEATURES

- 5 years manufacturer's warranty
- Modular 8 channel A:B switch
- Standard 19" rack
- Reversible mounting tabs
- Designed for use with iHP and LCM4000 product families
- 100% digital control
- Intelligent zero current switching when used with Artesyn devices
- Digital communication via RS485 (Modbus-RTU)
- Cloud based User configurable GUI
- Natural convection cooled (No Fan)
- Field upgradeable firmware
- Up to 16 racks are addressable from one control node
- Configurable baud rate
- MTBF 400K hours per Telecordia SR-332 Method 1 Case 3, Part Stress
- Product lifetime 10 years minimum

SAFETY

- EN62368-1
- UL/CSA62368-1
- IEC62368-1/60601-1

TARGET APPLICATIONS

- Horticulture
- Industrial
- Burn-in

*i*TS

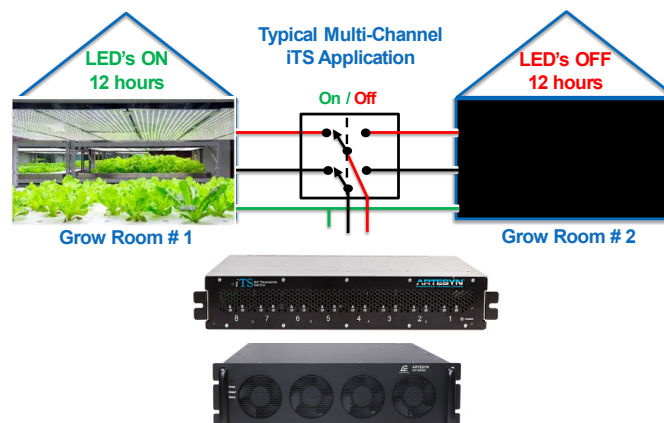

ITS ELECTRICAL SPECIFICATIONS – HOUSEKEEPING POWER SUPPLY MODULE

Parameter	Value
AC Input Voltage	90 to 264 Vac
AC Input Frequency	50/60 Hz Nominal
AC Input Fusing	Included for both input AC lines (not user serviceable)
AC Inrush Current	Upon start-up from a “cold start”, the maximum AC input current shall NOT exceed 50 Amps at 264 VAC 25 degC
Output to Relay Module	12V @1A per module; 3V3 as reference voltage +/-1%

ITS ELECTRICAL SPECIFICATIONS – RELAY MODULE

Parameter	Value
Description	<p>The relay is double break, capable for 25A max continuous operation. Both output lines, positive and return, are switched. To prevent arcing, the relay is only switched when zero voltage / zero current is flowing through the contacts (Provided by master software control of the power source and Relay MCU.)</p> <p>The relay module will support iHP modules with nominal voltage rating of 125VDC, 200VDC and 250VDC along with 250VDC of the LCM4000HV. iHP modules connected in series for higher voltage output is allowed, but the load maybe derated so as not to exceed the switching power rating of the relay.</p>
# Inputs	One per relay module, up to 8 can be loaded in a single 2U rack
Nominal Input Voltage	90V – 264VAC
Input Current Max	25A
Input current Fault	>28A

DIGITAL INPUT AND OUTPUT SIGNALS

Signal Name	Signal Description
PRESENT(OUTPUT)	Low asserted, to be used by MCU module to denote which slot have available relay module. To be connected ground (SGND) in relay module
Drive_A (INPUT)	High asserted, to drive relay for output A. Minimum drive strength of 8mA is required
Drive_B (INPUT)	High asserted, to drive relay for output B. Minimum drive strength of 8mA is required
FAULT_1 (OUTPUT)	Low asserted, to trigger fault if relay coil voltage drop is >5VDC on the active relay. And if input source is turned on and both Relay A and B are off
FAULT_2 (OUTPUT)	Low asserted, to trigger fault if both output A and B are active (note: in the event of only relay drive active but other relay is welded/shorted). And if either output A or B is active but there is no active drive
SGND (OUTPUT)	Digital ground reference of MCU module and relay module

Note: FAULT_1 and FAULT_2 should trigger a response from MCU module to shutdown iHP or LCM4000HV PSU output designated to the relay module with fault.

EMC/IMMUNITY

Parameter	All Models (Unless otherwise specified)
Power Frequency Magnetic Field	EN61000-4-8
Voltage Dips, Short Interruptions and Voltage Variations	EN 61000-4-34

Electromagnetic Compatibility	ALL MODELS			
	Category	Standard	Frequency	Level / Limits
Radiated Emissions	EN 55011/CISPR11	30M -1GHz	Class A	5dB Margin
	FCC CFR 47, Part 15, Subpart B	30M-1GHz >1GHz (see standard)	Class A	5dB Margin
Conducted Emissions	EN 55011/CISPR11	150k-30MHz	Class A	5dB Margin
Power Line Harmonics ²	EN 61000-3-12	See standard	See standard	
Voltage Fluctuations ²	EN 61000-3-11	See standard	See standard	
Radiated Immunity	EN 61000-4-3	80M-2GHz	10 V/meter	A
ESD	EN 61000-4-2		8 KV contact, 15 KV Air	A
Electrical Fast Transient	EN 61000-4-4		+/- 4 KV	A
Surge AC	EN 61000-4-5		2KV DM, 4KV CM	A
	IEEE C62.41		2KV DM, 2KV CM 6 KV, CM & DM	A Fail Safe
Conducted Susceptibility	EN 61000-4-6	150 KHz – 80 MHz	10Vrms	A

Notes: 1. Performance Criteria as defined by EN 300 386 V1.3.3

2. Applies to AC power supplies only (includes all categories and parameters).

ENVIRONMENTAL OPERATING CONDITIONS

Operating Temperature	0°C to +50°C at 100% rated load					
Storage Temperature	-40°C to +85°C					
Operating Humidity	20% - 90% non-condensing					
Storage Humidity	10% - 95% non-condensing					
Vibration	Reference Standard Relay Specification					
Shock	Reference Standard Relay Specification					
Shipping and Handling	NSTA for <100 lbs					
Cooling and Audible Noise	<45 dBA using convection cooling					
Ingress Protection	IP20					
Pollution Degree	2					
RoHS Compliance	See Note Below					
Production Hipot	Zone	Hipot Voltage	Trip Current	Arc Detect	Ramp	Test Time
	Primary-to-EARTH	2500Vdc	5mA	Medium or 5mA	500V/s	2s
	Primary-to-Secondary	2500Vdc	5mA	Medium or 5mA	500V/s	2s
	Secondary-to-EARTH	2500Vdc	5mA	Medium or 5mA	500V/s	2s

Note: The Artesyn Technologies, Inc. "Products" meet the generally accepted RoHS 6/6 specification. Compliance with this specification includes all the components, parts, assemblies, and packaging of this product. Restricted Materials are not contained in the product or used in the manufacturing of this product or its components above the designated thresholds.

SIGNAL TIMING DIAGRAM

ITEM	DESCRIPTION	MIN	MAX
T_on_delay (t1)	Delay from driving the relay to the voltage being present at the output	100ms	-
T_off_delay (t2)	Delay from output voltage loss to the relay drive deactivation	-	2s
T_transfer delay (t3)	Delay from deactivation of relay activation of adjacent relay.	-	2s

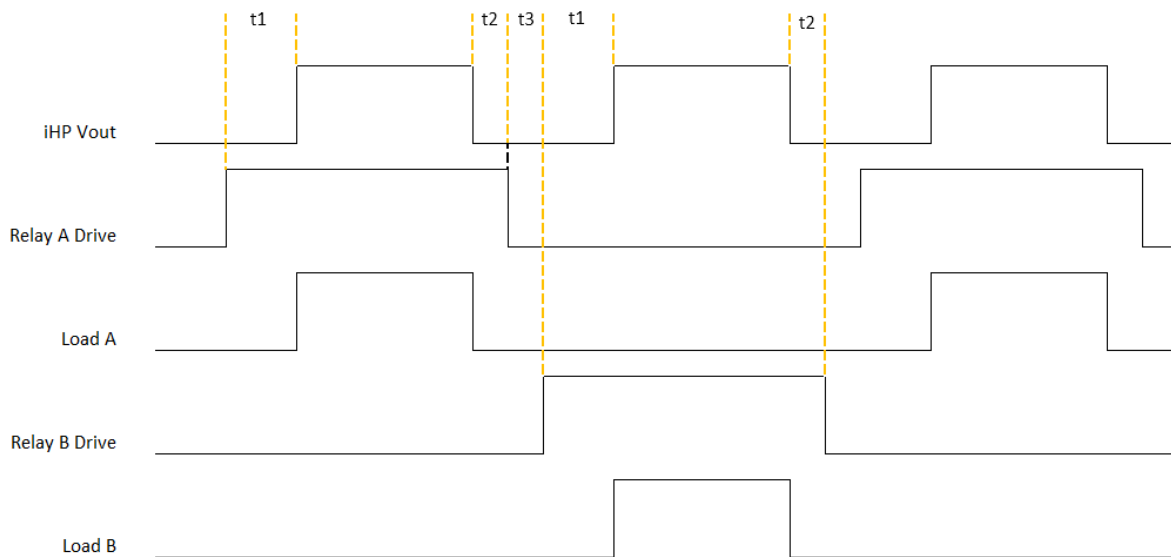

MECHANICAL REQUIREMENTS

Mechanical Drawing

Rack Size

Height = 81mm (2U)
 Width = 447mm
 Depth = 320.1mm

Relay module Size

Height = 76.8 mm
 Width = 44.4 mm
 Depth= 301.3 mm

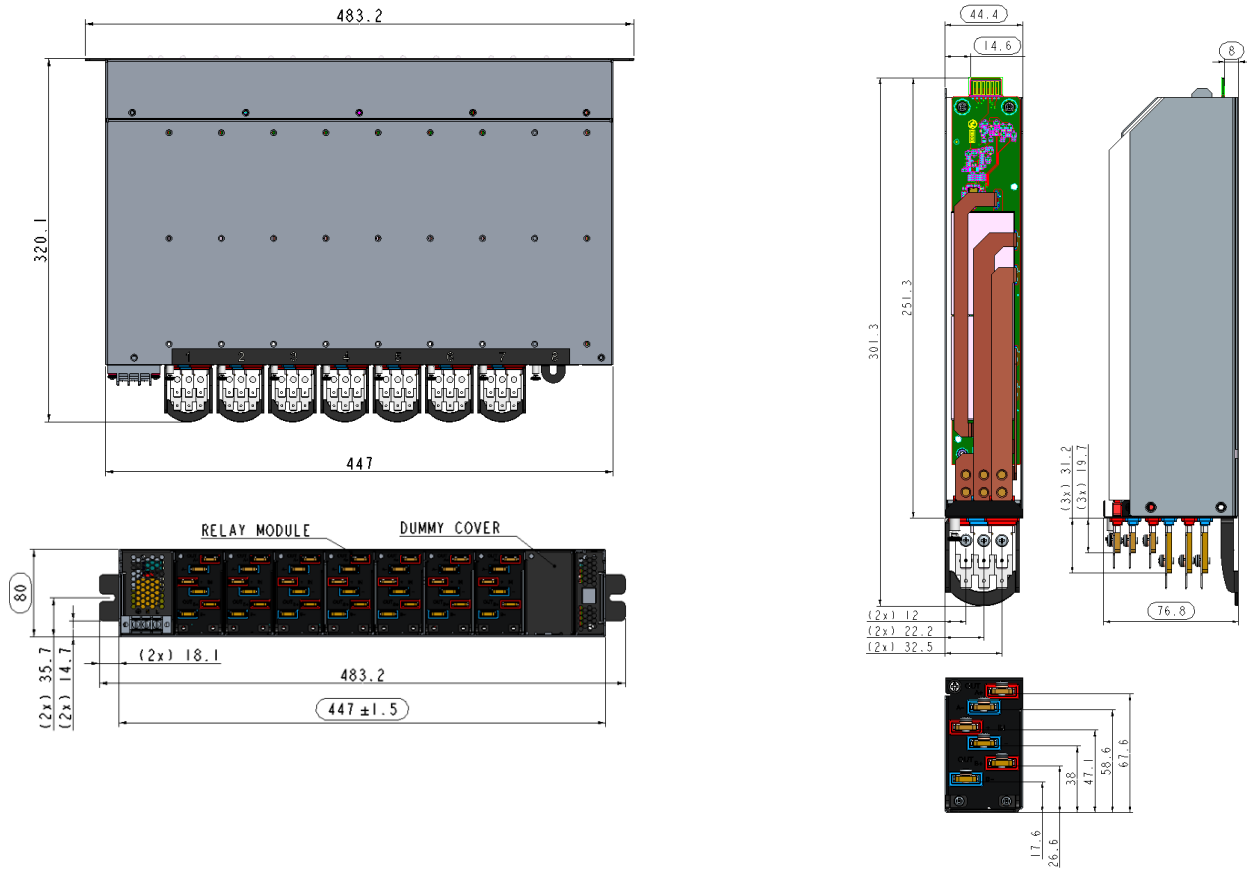

CONNECTORS

Input – Terminal Block

L	Live input (1Ø)
N	Neutral input (1Ø)
	Protective Earth (PE) input

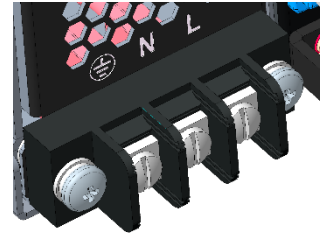

Output – Busbar with Faston tab Accessory

OUT A+	Switched Output A+
OUT A-	Switched Output A-
IN +	DC Input +
IN -	DC Input -
OUT B+	Switched Output B+
OUT B-	Switched Output B-

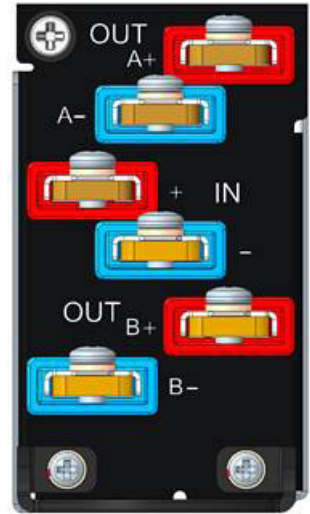

Communication Interface – RJ11 jacks for RS485

Pin 1	No Connection
Pin 2	No Connection
Pin 3	Ground
Pin 4	5V+
Pin 5	A+
Pin 6	B-

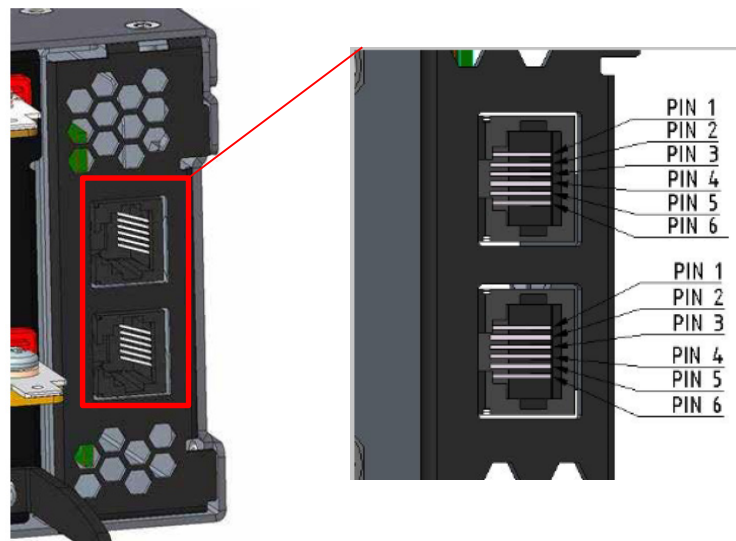

Rack Mounting Ears are detachable and can be placed in either the front or backside of the shelf

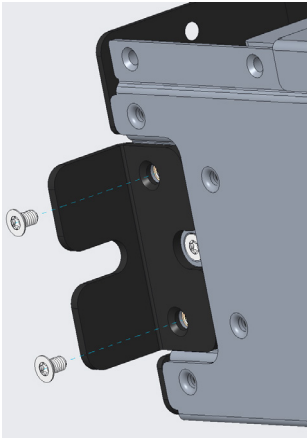

ORDERING INFORMATION

Model	Configuration
73-779-008	Fully Configured, Rack with 8 relay modules
73-779-007	Rack with 7 relay modules
73-779-006	Rack with 6 relay modules
73-779-005	Rack with 5 relay modules
73-779-004	Rack with 4 relay modules
73-779-003	Rack with 3 relay modules
73-779-002	Rack with 2 relay modules
73-779-001	Rack with 1 relay module
73-779-000	Relay module only
73-779-TBD	Blank Relay Module



For international contact information,
visit advancedenergy.com.

powersales@aei.com (Sales Support)
productsupport.ep@aei.com (Technical Support)
+1 888 412 7832

ABOUT ADVANCED ENERGY

Advanced Energy (AE) has devoted more than three decades to perfecting power for its global customers. AE designs and manufactures highly engineered, precision power conversion, measurement and control solutions for mission-critical applications and processes.

Our products enable customer innovation in complex applications for a wide range of industries including semiconductor equipment, industrial, manufacturing, telecommunications, data center computing, and medical. With deep applications know-how and responsive service and support across the globe, we build collaborative partnerships to meet rapid technological developments, propel growth for our customers, and innovate the future of power.

PRECISION | POWER | PERFORMANCE

Specifications are subject to change without notice. Not responsible for errors or omissions. ©2022 Advanced Energy Industries, Inc. All rights reserved. Advanced Energy®, AE® and Artesyn™ are U.S. trademarks of Advanced Energy Industries, Inc.