

Technical Reference Note

AET (30W) Family

AET (30W) Isolated DC/DC Converter Module ***Industry Standard Size, 2" x 1.6" x 0.48"*** ***9-36V/18-75V Inputs, 2.5V/3.3V/5V/12V/±12V/15V/±15V Outputs***

The AET (30W) Isolated DC/DC Converter is 4:1 wide input voltage family for low power applications. With efficiency up to 84% typical for 5V module, this product is allowed to work at operating temperature range from -40°C to 71°C and a wide input voltage range of 4:1. Single-output and dual-output models are available for a wide range of applications in telecommunication, transportation equipment, etc.. Housed in small package, 2" x 1.6" x 0.48", with industry standard pinout, AET family eases the PCB designs and mechanical designs of customers' end products.



Industry Standard Size
2" x 1.6" x 0.48"

Special Features

- **Wide 4:1 input range**
- **High efficiency, 84% @5V**
- **-40°C to 90°C case surface operating temperature**
- **Input / Output isolation 1.5KVdc**
- **Low output ripple and noise**
- **Shielded metal case with size (2"x1.6"x0.48")**
- **Industrial standard pinout**
- **Lead-free soldering pins**
- **Fixed switching frequency (300KHz)**
- **Positive enable function**
- **Adjustable Output Voltage**
- **Built-in input filter meets EN55022 / FCC Class A without external components**

Environmental Specifications

- **Operating temperature: -40°C to +71°C**
- **Storage temperature: -55°C to +105°C**
- **RoHS compliant**



Electrical Parameters

Input

Input range	9-36 VDC; 18-75 VDC
Input Surge	50V / 100ms; 100V / 100ms
Efficiency	84% @5V (Typical)

Output

Regulation (Line, Load, Temp)	<1.5%
Ripple and noise	100mV p-p max
Output Voltage Adjust Range	± 10% of nominal output
Transient Response	5% max deviation with 50% load to full load 300uS (max) recovery
Short Circuit Protection	Indefinite
Over Voltage Protection	120-140% nominal output
Over Temperature Protection	100 to 120°C case surface

Safety

Designed to meet EN60950

Technical Reference Note

AET (30W) Family



AET (30W) SERIES

THIS SPECIFICATION COVERS THE REQUIREMENTS
FOR AN INDUSTRY STANDARD PACKAGE OF 2"x1.6"x0.48", 4:1 INPUT RANGE,
30W, SINGLE OUTPUT AND DUAL OUTPUT ISOLATED DC/DC CONVERTER

PART NUMBERS

MODEL NAME / SIS CODE	Nominal Vin ($V_{I, \text{nom}}$) / Range of Vin	Vout / Iout
AET08G18-L	24V / 9-36V	2.5V / 8A
AET07F18-L	24V / 9-36V	3.3V / 7A
AET06A18-L	24V / 9-36V	5V / 6A
AET02B18-L	24V / 9-36V	12V / 2.5A
AET01BB18-L	24V / 9-36V	±12V / ±1.25A
AET02C18-L	24V / 9-36V	15V / 2A
AET01CC18-L	24V / 9-36V	±15V / ±1A
AET08G36-L	48V / 18-75V	2.5V / 8A
AET07F36-L	48V / 18-75V	3.3V / 7A
AET06A36-L	48V / 18-75V	5V / 6A
AET02B36-L	48V / 18-75V	12V / 2.5A
AET01BB36-L	48V / 18-75V	±12V / ±1.25A
AET02C36-L	48V / 18-75V	15V / 2A
AET01CC36-L	48V / 18-75V	±15V / ±1A

Technical Reference Note

AET (30W) Family



ELECTRICAL SPECIFICATIONS

STANDARD TEST CONDITION on a single unit, unless otherwise specified.

T_A :	25°C (Ambient Air)
+Vin :	24V \pm 2% (AETxxxx18-L) 48V \pm 2% (AETxxxx36-L)
-Vin :	Return pin for +Vin
Enable:	Open (Positive Enable)
+Vout :	Connect to load
-Vout :	Connect to load (return)
Trim (Vadj) :	Open

ABSOLUTE MAXIMUM RATINGS

Stresses in excess of the absolute maximum ratings can cause permanent damage to the device. These are absolute stress ratings only. Functional operation of the device is not implied at these or any other conditions in excess of those given in the operational sections of the IPS. Exposure to absolute maximum ratings for extended periods can adversely affect device reliability.

Parameter	Device	Symbol	Min	Typ	Max	Unit
a) Input Voltage:						
Continuous:	AETxxxx18-L	V_I	0	-	36	V_{dc}
Transient (100ms)	AETxxxx18-L	$V_{I,trans}$	0	-	50	V_{dc}
Continuous:	AETxxxx36-L	V_I	0	-	75	V_{dc}
Transient (100ms)	AETxxxx36-L	$V_{I,trans}$	0	-	100	V_{dc}
b) Operating Temperature						
Ambient	All	T_A	-40	-	71	°C
Case Surface		T_C	-40	-	100	°C
c) Storage Temperature	All	T_{STG}	-55	-	105	°C
d) Operating Humidity	All	-	-	-	95	%
e) I/O Isolation (Conditions : 0.5mA for 60 sec)						
Input-Output	All	-	-	-	1500	V_{dc}
f) Output Power						
	2.5V	$P_{o,max}$	-	-	20	W
	3.3V	$P_{o,max}$	-	-	23.1	W
	Others	$P_{o,max}$	-	-	30	W

Technical Reference Note AET (30W) Family



INPUT SPECIFICATIONS

Parameter	Device	Symbol	Min	Typ	Max	Unit	
a) Operating Input Voltage	AETxxxx18-L	V_I	9	24	36	V_{dc}	
	AETxxxx36-L	V_I	18	48	75	V_{dc}	
b) Maximum Input Current AETxxxx18-L ($V_I = 0$ to $V_{I,max}$; $I_o = I_{o,max}$)	2.5V	$I_{I,max}$	-	-	3.5	A	
	3.3V	$I_{I,max}$	-	-	4	A	
	5V	$I_{I,max}$	-	-	5	A	
	12V / $\pm 12V$	$I_{I,max}$	-	-	5	A	
	15V / $\pm 15V$	$I_{I,max}$	-	-	5	A	
	AETxxxx36-L ($V_I = 0$ to $V_{I,max}$; $I_o = I_{o,max}$)	2.5V	$I_{I,max}$	-	-	2	A
		3.3V	$I_{I,max}$	-	-	2.5	A
		5V	$I_{I,max}$	-	-	3	A
		12V / $\pm 12V$	$I_{I,max}$	-	-	3	A
		15V / $\pm 15V$	$I_{I,max}$	-	-	3	A
	c) No Load Input Power ($V_I = V_{I,nom}$)	All	-	-	-	0.5	W
	d) Recommended External Fuse Ratings	AETxxxx18-L					
2.5V				-	4	-	A
3.3V				-	5	-	A
5V				-	6	-	A
12V / $\pm 12V$				-	6	-	A
15V / $\pm 15V$			-	6	-	A	
AETxxxx36-L		2.5V		-	3	-	A
		3.3V		-	3	-	A
		5V		-	4	-	A
		12V / $\pm 12V$		-	4	-	A
		15V / $\pm 15V$		-	4	-	A

CAUTION: This power module is not internally fused. An input fuse must always be used.

Technical Reference Note AET (30W) Family



OUTPUT SPECIFICATIONS

Parameter	Device	Symbol	Min	Typ	Max	Unit
a) Output Voltage Setpoint ($V_I = V_{I, \min}$ to $V_{I, \max}$; $I_o = I_{o, \max}$; $T_A = 25^\circ\text{C}$)	2.5V	$V_{o, \text{set}}$	2.46	2.50	2.54	V_{dc}
	3.3V	$V_{o, \text{set}}$	3.25	3.30	3.35	V_{dc}
	5V	$V_{o, \text{set}}$	4.92	5.00	5.08	V_{dc}
	12V	$V_{o, \text{set}}$	11.82	12.00	12.18	V_{dc}
	15V	$V_{o, \text{set}}$	14.77	15.00	15.23	V_{dc}
	$\pm 12\text{V}$	$V_{o, \text{set}}$	± 11.82	± 12.00	± 12.18	V_{dc}
	$\pm 15\text{V}$	$V_{o, \text{set}}$	± 14.77	± 15.00	± 15.23	V_{dc}
b) Output Regulation: Line ($V_I = V_{I, \max}$ to $V_{I, \min}$; $I_o = I_{o, \max}$) Load ($V_I = V_{I, \text{nom}}$; $I_o = I_{o, \min}$ to $I_{o, \max}$) Cross ($V_I = V_{I, \text{nom}}$; $I_o = +I_{o, \max}, -I_{o, \min}$ or $+I_{o, \min}, -I_{o, \max}$ to $+I_{o, \max}, -I_{o, \max}$) Temperature ($T_c = -40^\circ\text{C}$ to $+100^\circ\text{C}$)	All	-	-	-	0.5	%
	All	-	-	-	0.5	%
	$\pm 12\text{V}/\pm 15\text{V}$	-	-	-	4	%
	All	-	-	-	1	% V_o
c) Output Ripple and Noise (Across $1\mu\text{F}$ @50V, X7R ceramic capacitor & $10\mu\text{F}$ @25V tantalum capacitor) See Figure 1. Peak-to-Peak (5 Hz to 20 MHz)	All	-	-	-	100	mVp-p
d) Rated Output Current Single Output Dual Output	2.5V	I_o	800	-	8000	mA
	3.3V	I_o	700	-	7000	mA
	5V	I_o	600	-	6000	mA
	12V	I_o	250	-	2500	mA
	15V	I_o	200	-	2000	mA
	$\pm 12\text{V}$	I_o	± 125	-	± 1250	mA
	$\pm 15\text{V}$	I_o	± 100	-	± 1000	mA
e) Efficiency ($V_I = V_{I, \text{nom}}$; $I_o = I_{o, \max}$; $T_A = 25^\circ\text{C}$)	2.5V	-	-	79	-	%
	3.3V	-	-	82	-	%
	5V	-	-	84	-	%
	12V	-	-	85	-	%
	15V	-	-	85	-	%
	$\pm 12\text{V}$	-	-	85	-	%
	$\pm 15\text{V}$	-	-	85	-	%
f) Switching Frequency	All	-	270	300	330	KHz

Technical Reference Note AET (30W) Family



OUTPUT SPECIFICATIONS (Cont.)

Parameter	Device	Symbol	Min	Typ	Max	Unit
g) Dynamic Response : ($\Delta I_o/\Delta t = 0.08A/\mu s$; $V_I = V_{I, nom}$; $T_A = 25^\circ C$)						
Load Change from $I_o = 50\%$ to 100% of $I_{o, max}$	2.5V/3.3V/5V	-	-	-	5	%Vo
	12V/±12V/15V/±15V	-	-	-	2	%Vo
Peak Deviation Settling Time (to $V_{o, nom}$)	All	-	-	-	300	μsec
h) Turn-On Time ($I_o = I_{o, max}$; V_o within 1%)	All	-	-	6	10	msec
i) Output Voltage Overshoot ($I_o = I_{o, max}$; $T_A = 25^\circ C$)	All	-	-	1	4	%Vo

FEATURE SPECIFICATIONS

Parameter	Device	Symbol	Min	Typ	Max	Unit
Enable Pin Voltage						
Logic Low	All	OFF	-0.7	-	1.0	V
Logic High	All	ON	3.0	-	V_I	V
OPEN	All	ON	-	-	-	
Enable Pin Current						
Logic Low	All	OFF	-	-	2	mA
Logic High (leakage current, @ V_I)	All	ON	-	-	50	uA
OPEN	All	ON	-	-	0	uA
Output Voltage Adjustment Range	All	-	90	-	110	%Vo
Output Overvoltage Clamp	2.5V	$V_{o, clamp}$	3.0	-	3.5	V
	3.3V	$V_{o, clamp}$	4.0	-	4.6	V
	5V	$V_{o, clamp}$	6.0	-	7.0	V
	12V	$V_{o, clamp}$	14.4	-	16.8	V
	15V	$V_{o, clamp}$	18.0	-	20.0	V
	±12V	$V_{o, clamp}$	±14.4	-	±16.8	V
	±15V	$V_{o, clamp}$	±18.0	-	±20.0	V
Overtemperature Clamp	All	$T_{c, clamp}$	100	-	120	°C

Technical Reference Note AET (30W) Family



FEATURE SPECIFICATIONS (Cont.)

Undervoltage Lockout Turn-on Point	AETxxxx18-L	-	-	8.7	9	V
	AETxxxx36-L	-	-	16.5	18	V
Turn-off Point	AETxxxx18-L	-	6.5	8.5	-	V
	AETxxxx36-L	-	13	15	-	V
Isolation Capacitance	All	-	-	1000	-	PF
Isolation Resistance	All	-	10	-	-	MΩ
Calculated MTBF ($I_o = I_{o, max}$; $T_A = 25^\circ\text{C}$)	All	-	400K	500K	-	Hours
Weight	All	-	-	-	70	g

TEST SETUP

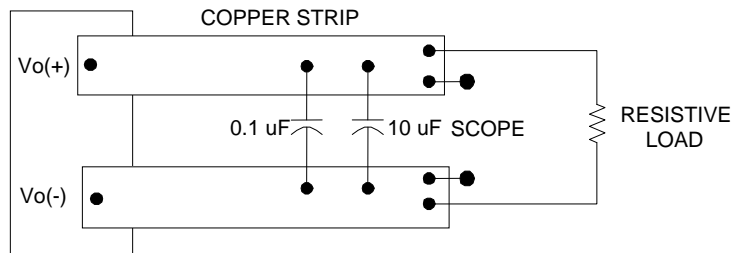

Note: Use a 0.1μF @50V X7R ceramic capacitor and a 10μF @25V tantalum capacitor. Scope measurement should be made using a BNC socket. Position the load between 51 mm and 76 mm (2 in. and 3 in.) from module.

Figure 1 : Peak-to-Peak Output Noise Measurement Test Setup

Technical Reference Note AET (30W) Family



Basic Operation and Features

The AET converters were designed specifically to address applications where high power density is required. These modules provide 1500Vdc isolation and operate from the input ranges of 9V-36V and 18V-75V with standard features such as Enable, Trim, OCP, OVP and OTP.

Output Overcurrent Protection

To provide protection in an output overload or short circuit condition, the converter is equipped with current limiting circuitry and can endure the fault condition for an unlimited duration. At the point of current-limit inception, the converter goes into “Hiccup Mode”, causing the output current to be limited both in peak and duration. The converter will operate back normally once the output current is brought back into its specified range.

Output Overvoltage Protection

The output overvoltage system consists of a separate control loop, independent of the primary control loop. This control loop has a higher voltage set point than the primary loop. In a fault condition of output overvoltage, the converter latches and clamps the output to a lower voltage level to ensure that the output voltage does not exceed $V_{o, \text{clamp, max}}$. The converter will operate back normally once the fault is removed and the input voltage is cycled or the enable pin is toggled.

Overtemperature Protection

In a fault condition of overtemperature, the converter goes into “Hiccup Mode” to reduce heat generated internally and ensure that the case temperature does not exceed $T_{c, \text{clamp, max}}$. The converter will operate back normally once the case temperature is brought back below $T_{c, \text{clamp, min}}$.

Enable Function

Positive Logic Enable turns the converter on during a logic-high voltage or an open circuit on the enable pin, and off during a logic-low.

Trim Function

Output Voltage adjustment is accomplished by connecting an external resistor between the Trim Pin and either the +Vout or -Vout Pins.

To adjust V_o to a higher value, please refer to Figure 2.

An external resistor, R_{adj_up} , should be connected between the Trim Pin and the -Vout Pin. From equation (1), R_{adj_up} resistor can be determined for the required output voltage.

Equation (1)

$$\text{For } V_o=2.5V \text{ modules, } V_o = \frac{3800}{15200+R_{adj_up}} + 2.5$$

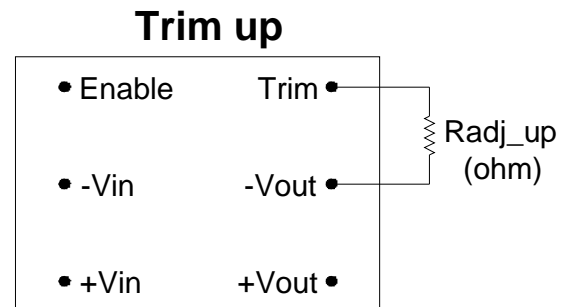

Figure 2. Circuit Configuration to Increase Output Voltage

Technical Reference Note AET (30W) Family

For Vo=3.3V modules,
$$V_o = \frac{2393}{7250+R_{adj_up}} + 3.3$$

For Vo=5V modules,
$$V_o = \frac{9550}{19100+R_{adj_up}} + 5$$

For Vo=12V modules,
$$V_o = \frac{37200}{31000+R_{adj_up}} + 12$$

For Vo=15V modules,
$$V_o = \frac{36450}{24300+R_{adj_up}} + 15$$

For Vo=±12V modules,
$$V_o = \pm \left| \left(\frac{87600}{36500+R_{adj_up}} + 24 \right) \div 2 \right|$$

For Vo=±15V modules,
$$V_o = \pm \left| \left(\frac{66300}{22100+R_{adj_up}} + 30 \right) \div 2 \right|$$

Where: R_{adj_up} is in Ω

V_o is not changed when R_{adj_up} is not connected

110% V_o is obtained when R_{adj_up} = 0 Ω (i.e. Trim Pin is shorted to -V_{out} Pin)

To adjust V_o to a lower value, please refer to Figure 3.

An external resistor, R_{adj_down}, should be connected between the Trim Pin and the +V_{out} Pin. From equation (2), R_{adj_down} resistor can be determined for the required output voltage.

Equation (2)

For Vo=2.5V modules,
$$V_o = \frac{35100+2.5 R_{adj_down}}{15600+R_{adj_down}}$$

For Vo=3.3V modules,
$$V_o = \frac{43956+3.3 R_{adj_down}}{14800+R_{adj_down}}$$

For Vo=5V modules,
$$V_o = \frac{86400+5 R_{adj_down}}{19200+R_{adj_down}}$$

For Vo=12V modules,
$$V_o = \frac{1468800+12 R_{adj_down}}{136000+R_{adj_down}}$$

For Vo=15V modules,
$$V_o = \frac{1957500+15 R_{adj_down}}{145000+R_{adj_down}}$$

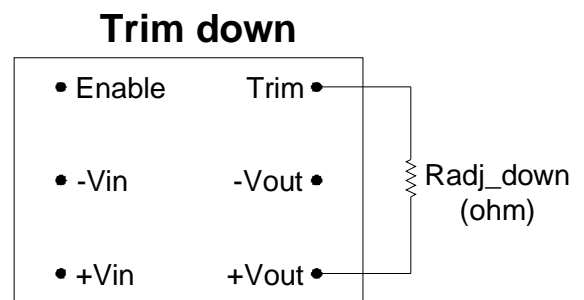

Figure 3. Circuit Configuration to Decrease Output Voltage

Technical Reference Note AET (30W) Family



For $V_o = \pm 12V$ modules, $V_o = \pm \left| \left(\frac{8152000 + 24 \text{ Radj_down}}{377400 + \text{Radj_down}} \right) \div 2 \right|$

For $V_o = \pm 15V$ modules, $V_o = \pm \left| \left(\frac{7971000 + 30 \text{ Radj_down}}{295220 + \text{Radj_down}} \right) \div 2 \right|$

Where: Radj_down is in Ω

V_o is not changed when Radj_down is not connected

90% V_o is obtained when Radj_down = 0 Ω (i.e. Trim Pin is shorted to +Vout Pin)

Performance Curves – Efficiency Curve

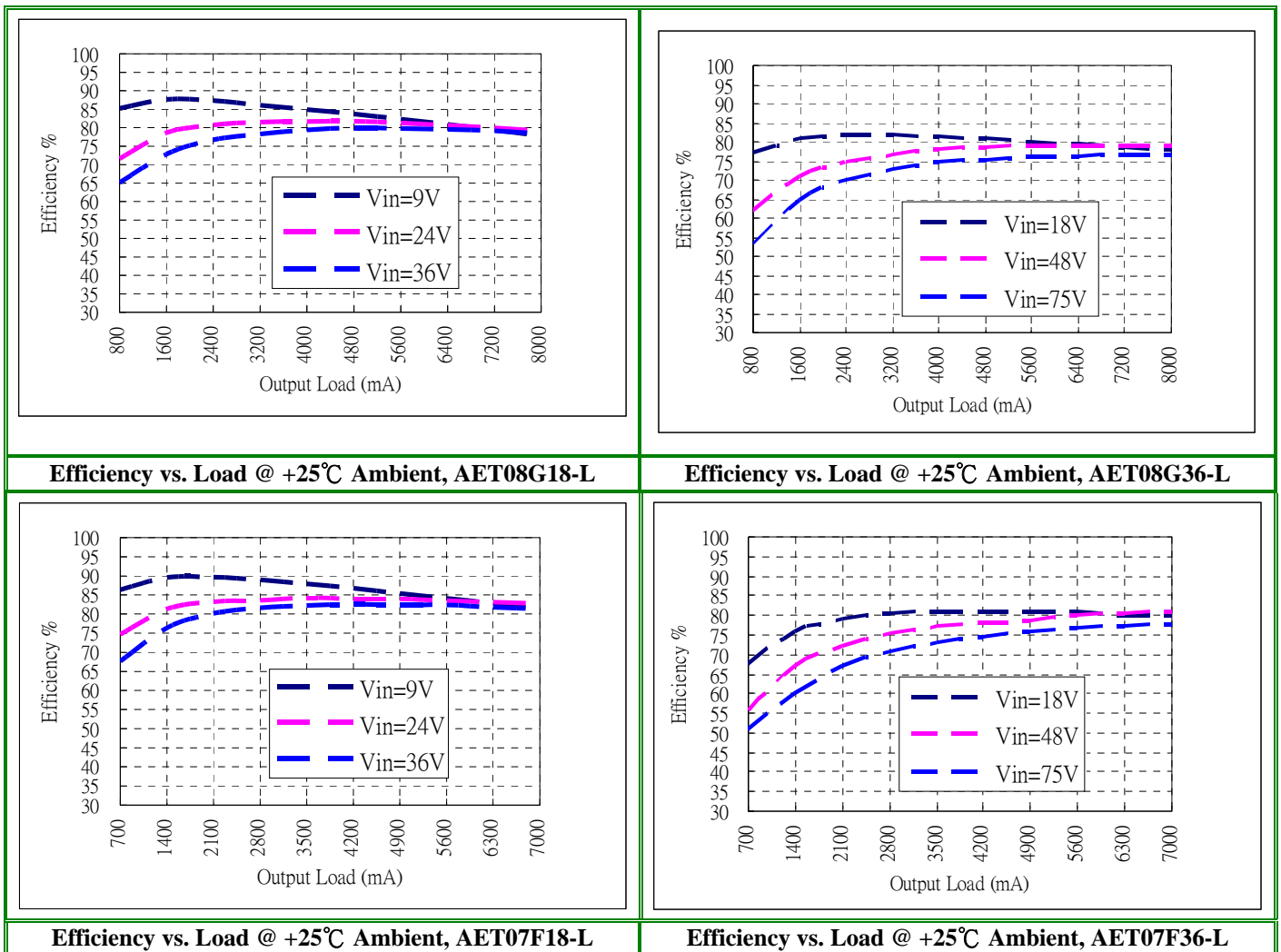

Technical Reference Note AET (30W) Family

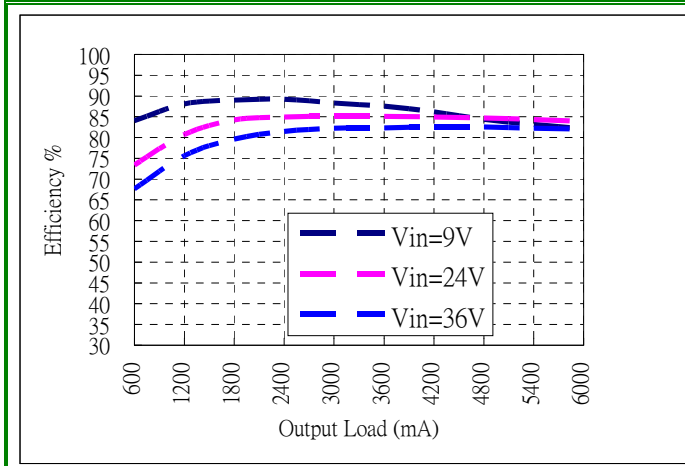

Efficiency vs. Load @ +25°C Ambient, AET06A18-L

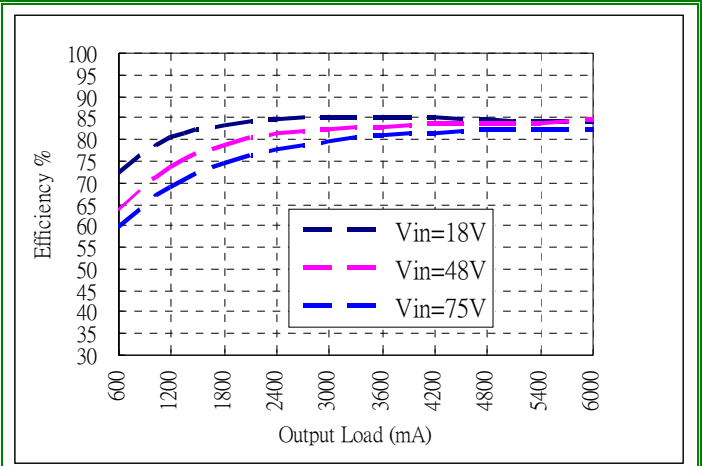

Efficiency vs. Load @ +25°C Ambient, AET06A36-L

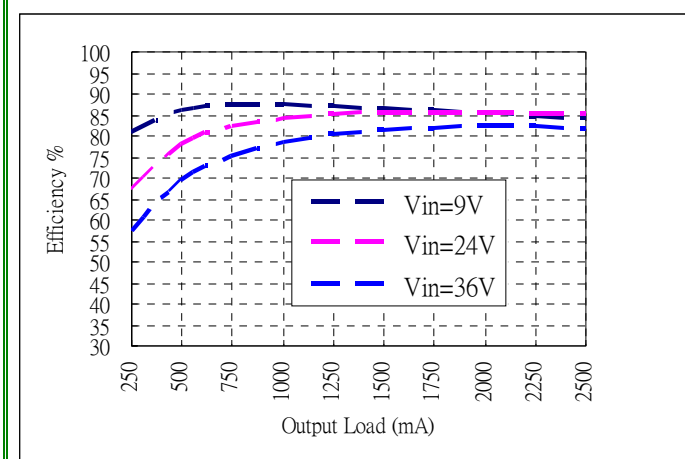

Efficiency vs. Load @ +25°C Ambient, AET02B18-L

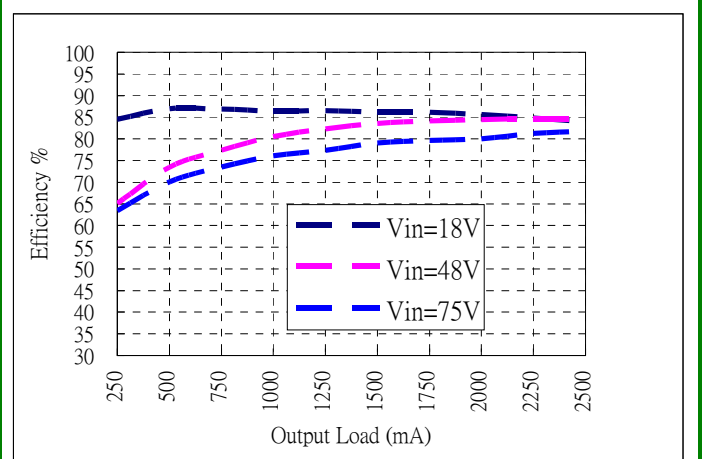

Efficiency vs. Load @ +25°C Ambient, AET02B36-L

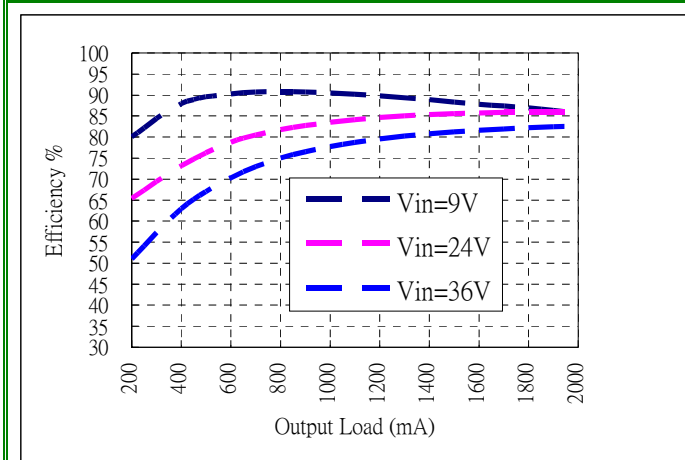

Efficiency vs. Load @ +25°C Ambient, AET02C18-L

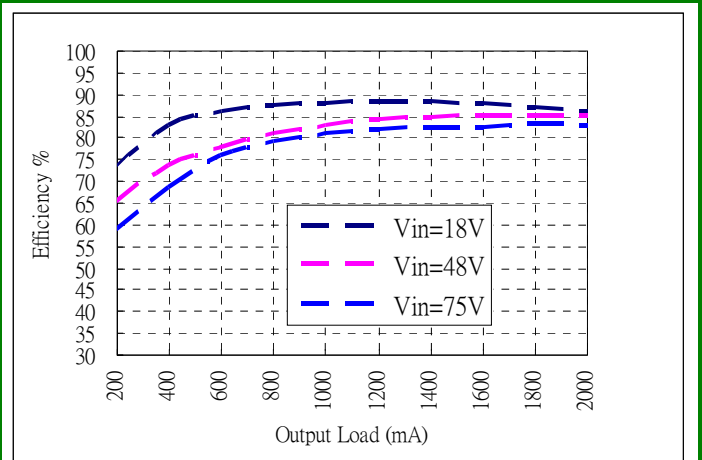

Efficiency vs. Load @ +25°C Ambient, AET02C36-L

Technical Reference Note AET (30W) Family

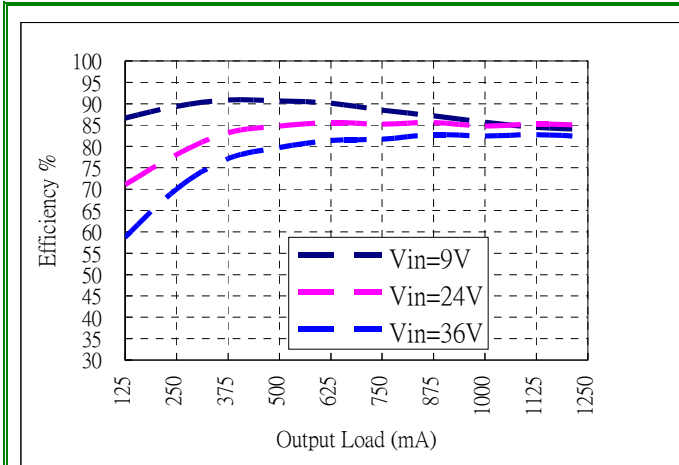

Efficiency vs. Load @ +25°C Ambient, AET01BB18-L

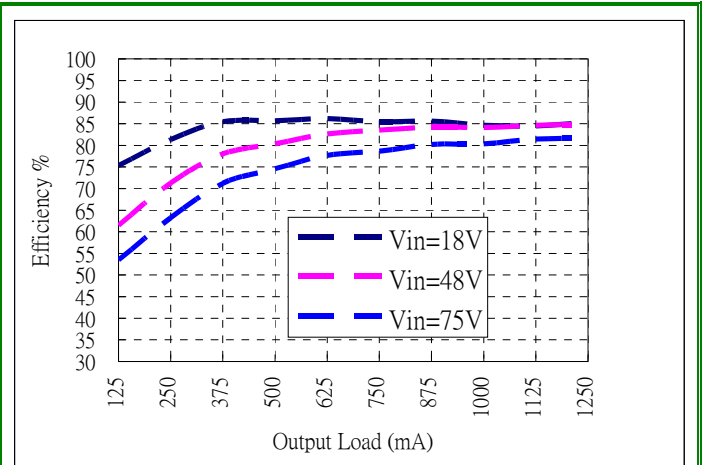

Efficiency vs. Load @ +25°C Ambient, AET01BB36-L

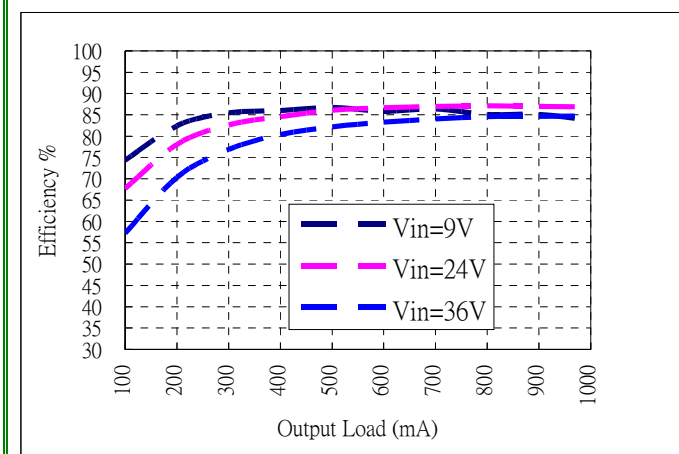

Efficiency vs. Load @ +25°C Ambient, AET01CC18-L

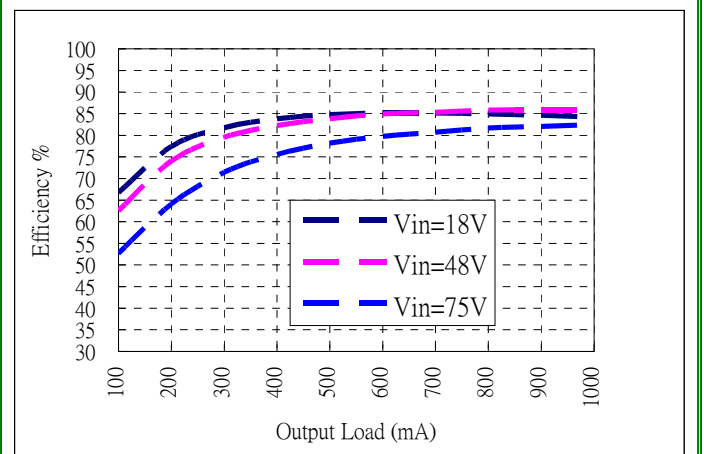

Efficiency vs. Load @ +25°C Ambient, AET01CC36-L

Technical Reference Note AET (30W) Family

Performance Curves

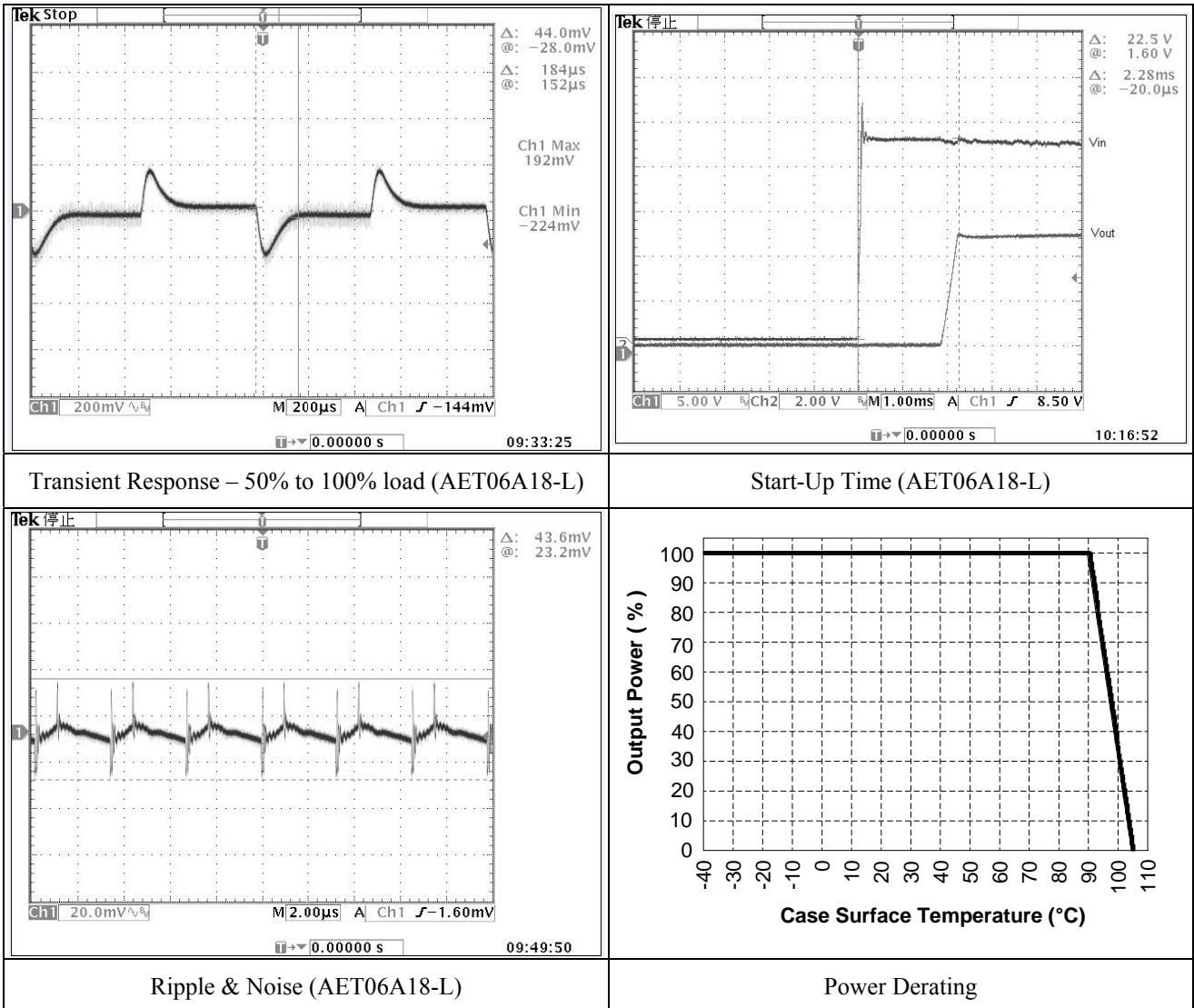

Technical Reference Note AET (30W) Family



Conducted EMI Performance

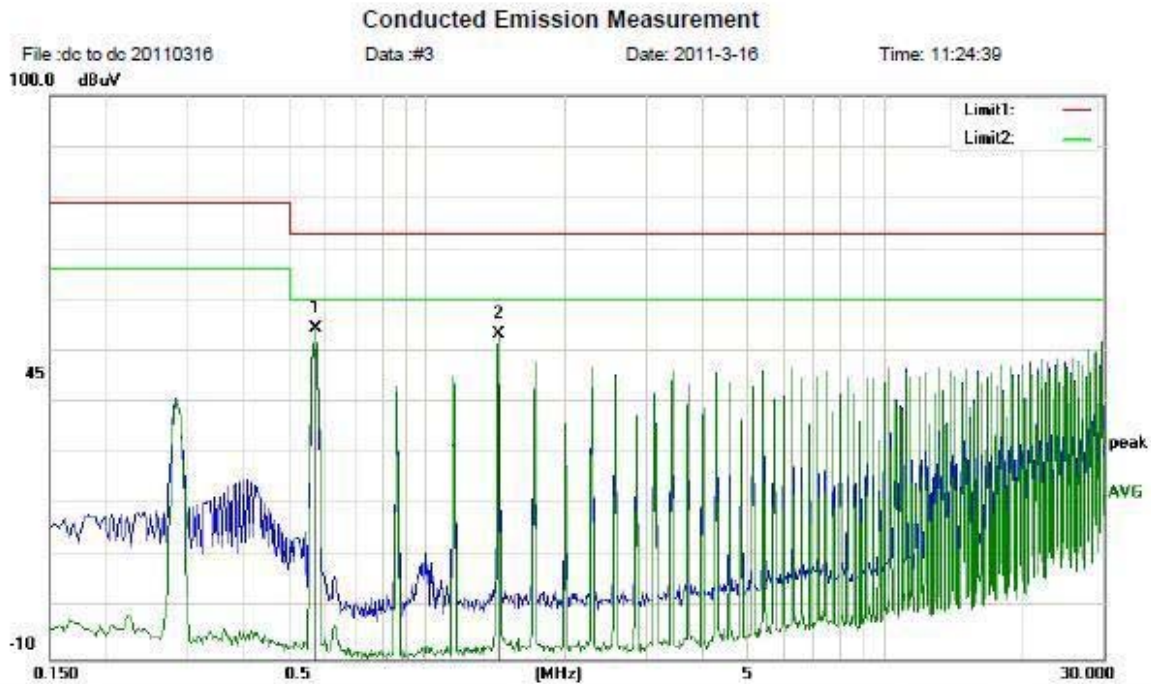

Site Chamber #1	Phase: <i>L</i>	Temperature: 20
Limit: (CE)EN55022 class A_QP	Power: DC 24V	Humidity: 57 %
EUT: dc to dc converter		Test Result: Pass
M/N: AET06A18-L		
Mode: Full Load		
Note:		

No.	Mk.	Freq.	Reading Level	Correct Factor	Measurement	Limit	Over	Detector	Comment
		MHz	dBuV	dB	dBuV	dBuV	dB		
1	*	0.5740	54.39	0.12	54.51	73.00	-18.49	peak	
2		1.4340	53.27	0.20	53.47	73.00	-19.53	peak	

Technical Reference Note AET (30W) Family



Conducted Emission Measurement

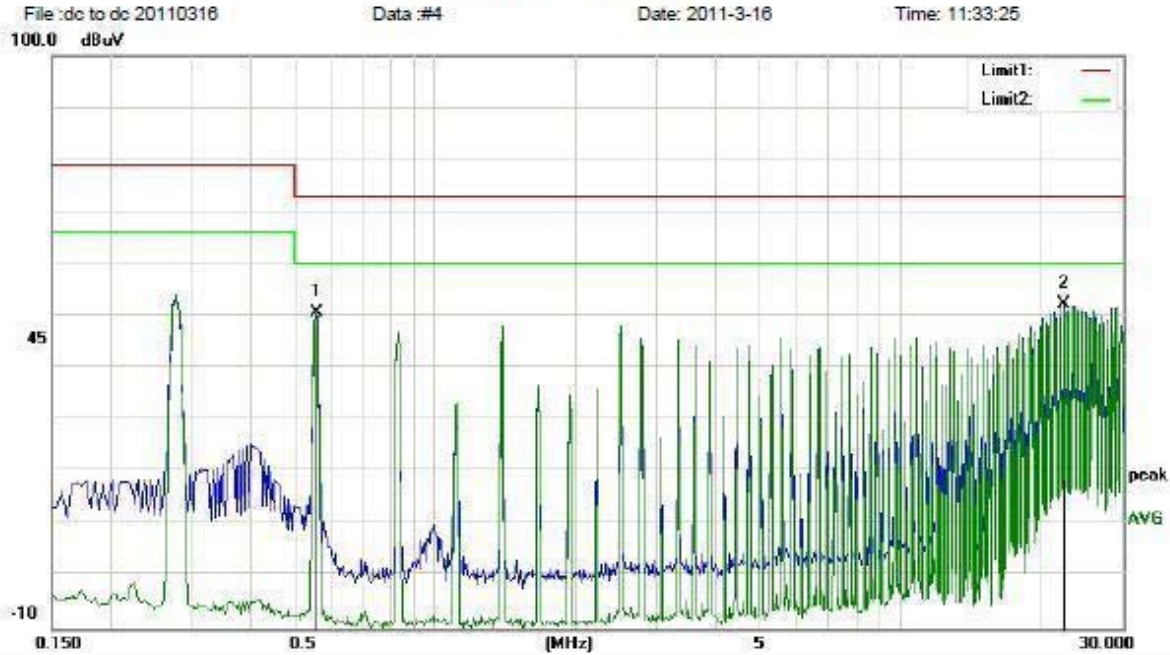

Site Chamber #1	Phase: <i>N</i>	Temperature: 20
Limit: (CE)EN55022 class A_QP	Power: DC 24V	Humidity: 57 %
EUT: dc to dc converter		Test Result: Pass
M/N: AET06A18-L		
Mode: Full Load		
Note:		

No.	Mk.	Freq. MHz	Reading Level dBuV	Correct Factor dB	Measure- ment dBuV	Limit dBuV	Over dB	Detector	Comment
1		0.5580	50.40	0.12	50.52	73.00	-22.48	peak	
2	*	22.4260	51.20	1.07	52.27	73.00	-20.73	peak	

Technical Reference Note AET (30W) Family



Mechanical Dimensions and Module Pin Assignment

Single Output

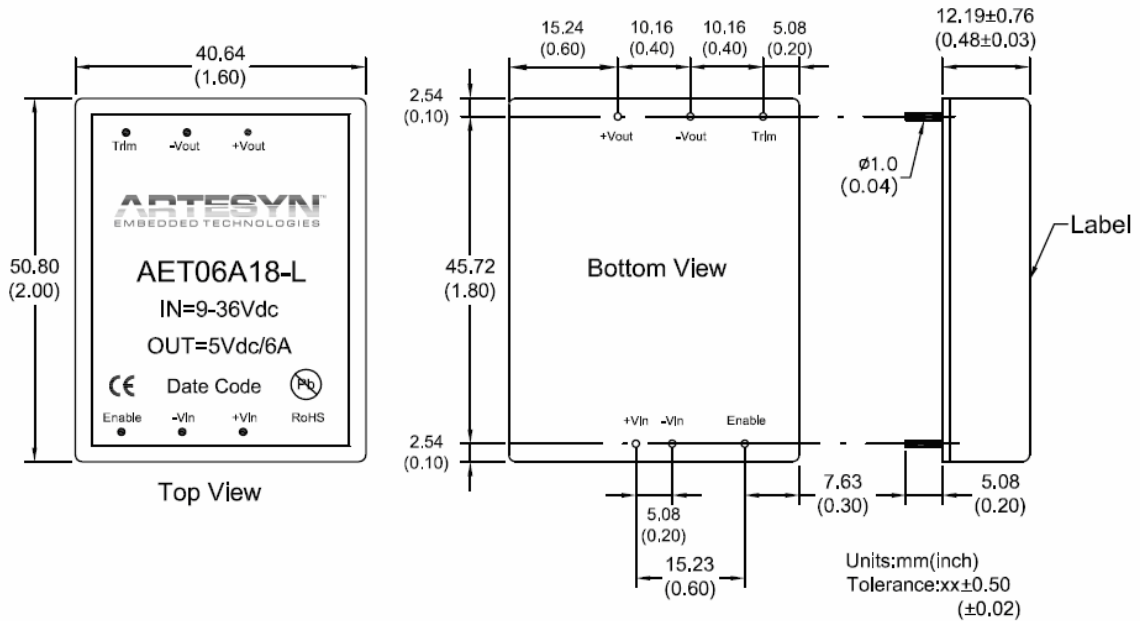

Dual Output

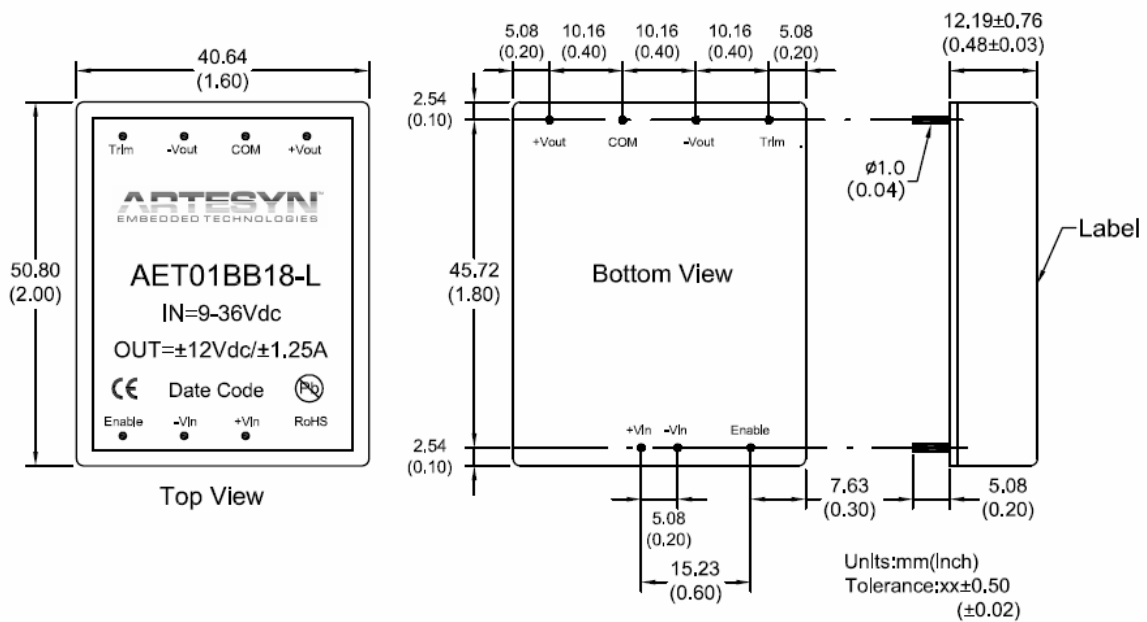

Technical Reference Note AET (30W) Family



Package Information

REV	REF	DESCRIPTION	AUTH	DATE

1. PACKING TUBE: 360*53.4*21.4mm ; ONE TUBE = 8 PCS
2. PRODUCTS: AET SERIES
3. STOPPER
4. INNER CARTON: 388*159*115mm
ONE INNER CARTON = 10 TUBES = 80 PCS
5. OUTER CARTON: 405*334*263mm
ONE OUTER CARTON = 4 INNER CARTONS = 320 PCS

STANDARD TOLERANCE LIMITS UNLESS OTHER SPECIFIED.			THIRD ANGLE PROJECTION	REV
RANGE	ANGLE	TOLERANCE		
>0~3	±1'	±0.1	UNIT:m/m SCALE 1 : 1	A1
>3~6	±2'	±0.15		
>6~30	±3'	±0.18		
>30~120	±5'	±0.20		

Technical Reference Note AET (30W) Family



Recommended Lead-Free Wave Soldering Temperature Profile

