

ARTESYN 50V 3kW OPEN RACK V3 PSU

For 18 kW 10U ORV3 Power Shelves



Advanced Energy's Artesyn introduces the ORV3 3 kW PSU for use in the Open Rack V3 Power System. The PSU is a single-phase AC to DC power supply that operates from nominal input voltage from 200 to 277 VAC and produces 50 V, 60 A (3 kW) DC output. Within the ORV3 10U Power Shelf, six of the ORV3 rectifiers operate in parallel, current sharing mode to produce 15 kW of N + 1 redundant power. The ORV3 Power System features a narrow DC voltage range to eliminate oversize design and enable high efficiency, fixed ratio downstream DC to DC conversion.

KEY FEATURES

- Peak efficiency 97.5%
- Efficiency greater than 96.5% for 230 VAC to 277 VAC and 30% to 100% load range
- 200 VAC to 277 VAC nominal input voltage range
- Active + Droop current sharing
- Hot swappable
- Cooling via internal fan with speed control
- Modbus/PMBus communications
- Interface for monitoring and control
- Black box fault logging

EMC / SAFETY COMPLIANCE

- IEC EN 61000-4-2 CAT A surges
- EN 61000-3-2 Class A harmonics
- CISPR and FCC Part A EMC
- UL 60950
- IEC 60950
- IEC/EN/UL 62368-1

AT A GLANCE

Total Output Power

3 kW

Input Voltage

180 to 305 VAC

Output Voltage

50.5 to 51 VDC

Mechanical Dimensions

73.5 x 525 x 40 mm (L x W x H)

Operating Temperature

-5°C to 40°C

ELECTRICAL SPECIFICATIONS

Absolute Maximum Ratings					
	Conditions	Min	Typ	Max	Unit
Input Voltage	AC continuous operation	180	-	305	VAC
Maximum Output Power		-	-	3	kW
Isolation Voltage	Input to outputs Input to safety ground				
Ambient Operating Temperature		-5	-	45	°C
Storage Temperature		-40	-	85	°C
Humidity (non-condensing)	Operating	10	-	90	%
	Non-operating	5	-	93	%
Altitude	Operating	0	-	3050	m
	Non-operating	0	-	12000	m
Input Specifications					
	Conditions	Min	Typ	Max	Unit
Input Voltage		180	200/277	305	VAC
Input AC Frequency		47	50/60	63	Hz
Input AC Start-up Voltage		-	178	-	VAC
Input AC Undervoltage Lockout Voltage		-	172	-	VAC
Fuse	Phase and return lines UL approved	14	-	-	kA
Turn On Time		-	-	5	s
Inrush Current		-	-	30	A
Hold Up Time ¹	200 to 277 VAC input 100% Load	-	20	-	ms
iTHD	5% to 10% load	-	-	15	%
	10% to 30% load	-	-	10	%
	30% to 100% load	-	-	5	%
Power Factor	10% to 30% load VIN < 250V	0.95	-	-	%
	10% to 30% load VIN > 250V	0.90	-	-	%
	30% to 100% load	0.98	-	-	%
Efficiency	Note 2	97.5	-	-	%
		96.5	-	-	%
		96.5	-	-	%
		95.5	-	-	%
		94.0	-	-	%

Note 1 - Refer to PSU-BBU Transition.

Note 2 - At peak 230, 240, 277 VAC input, the minimum efficiency is 97.5%.

At 230, 240, 277 VAC input, the minimum efficiency is 96.5%.

At peak 208VAC input, the minimum efficiency is 96.5%.

At 208VAC input, the minimum efficiency is 95.5%.

At 10 to 30% load, 208 to 277V AC input, the minimum efficiency is 94%.

ELECTRICAL SPECIFICATIONS

Output Specifications						
	Conditions	Min	Nom	Max	Unit	
Set Point	50% Load	50.625	50.750	50.875	VDC	
Output Current ¹		-	-	60	A	
Ripple & Noise	20MHz bandwidth	-	-	500	mVpp	
V _O Dynamic Response	Peak Deviation	10% min load				
		0 to 10 mF output cap.				
		Dynamic load @ 20Hz				
		Slew rate 1A/usec				
		50% step load	-	-	0.5	V
		90% step load	-	-	1.0	V
		140% step load	-	-	1.5	V
V _O Dynamic Response	Settling Time		3	-	ms	
Regulation and Droop characteristics		0.375	0.5	0.625	V	
Current Sharing Accuracy	20 to 50% load	-5	-	+5	%	
	50 to 100% load	-2	-	+2	%	
Output Rise Time		-	60	-	ms	
Short circuit protection (SCP)	If the rectifier voltage is lower than 10 V (short circuit condition), the rectifier shuts off immediately. No component will damage. The protection is hiccup mode. It tries to restart 5 times (2 second off, 200 ms on) and then locks out.					
Overcurrent protection (OCP)	If a PSU is overloaded higher than the values listed below, it will immediately reduce its voltage by 3 V and wait for 5 ms (to give enough time for BBU to take over). If overload is still there, PSU can shut down. After an overload fault, PSUs will retry 5 times to sync together and turn on once every 10 s. <ul style="list-style-type: none"> · Average power more than 3.3 kW for 10 s. · Average power more than 3.6 kW for 100 ms. · Repetitive pulse power more than the pulse power envelope specified (up to 150% load). 					
Overvoltage protection (OVP)	The rectifier will shut down for DC output voltage exceeding 52.5 V and the reacting time will not exceed 200 ms. For DC output voltage will never exceed 54 V (fast OVP).					
Overtemperature protection (OTP)	The rectifier employ over temperature protection for both ambient over temperature and internal thermal temperature to protect the rectifier. The rectifier will shut down under over temperature condition and recover after certain period after the over temperature condition is removed. The OTP circuit incorporate built in hysteresis such that the power supply does not oscillate on and off due to temperature recovering condition. The OTP event shall be reported as a fault condition.					

Note 1 - For surge current capabilities, see Pulse Load Operation.

PULSE LOAD OPERATION

PSU voltage should drop by 3V after its holdup energy is lost by 50% or 30J. Here, 24J or 40% of holdup energy is allocated for pulse power. As the result, PSU should meet the following pulse power envelope shown below without triggering BBU (reducing voltage by 3 V, which happens when holdup energy is reduced by 50%).

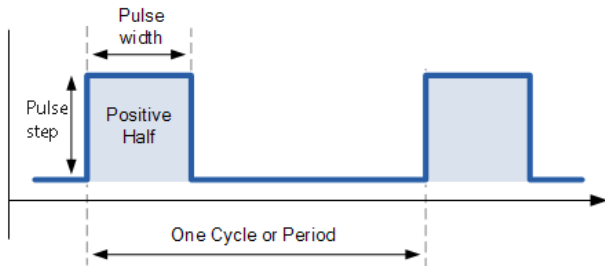

Allowable peak power step

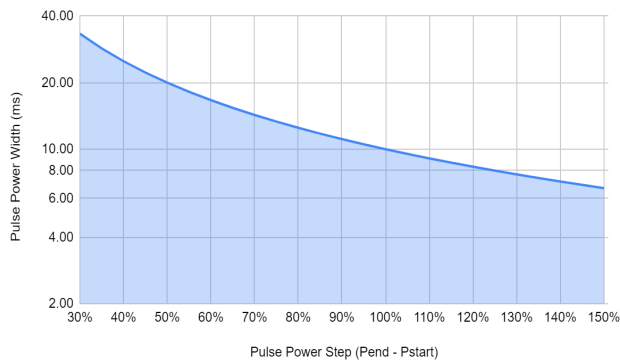

In order to meet the Pulse power requirements as the graph above, the dc-dc converter should meet the following absolute pulse power requirement as shown below. This graph comes from the worst case of P_{start} as 100%.

dc-dc converter pulse power requirement

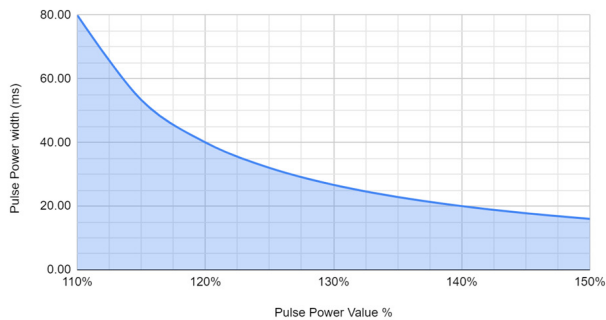

PSU-BBU TRANSITION

Graph below shows the PSU requirement to transition to BBU in case of AC outage. PSU voltage should drop by 3V after its holdup energy is lost by 50% or 30J.

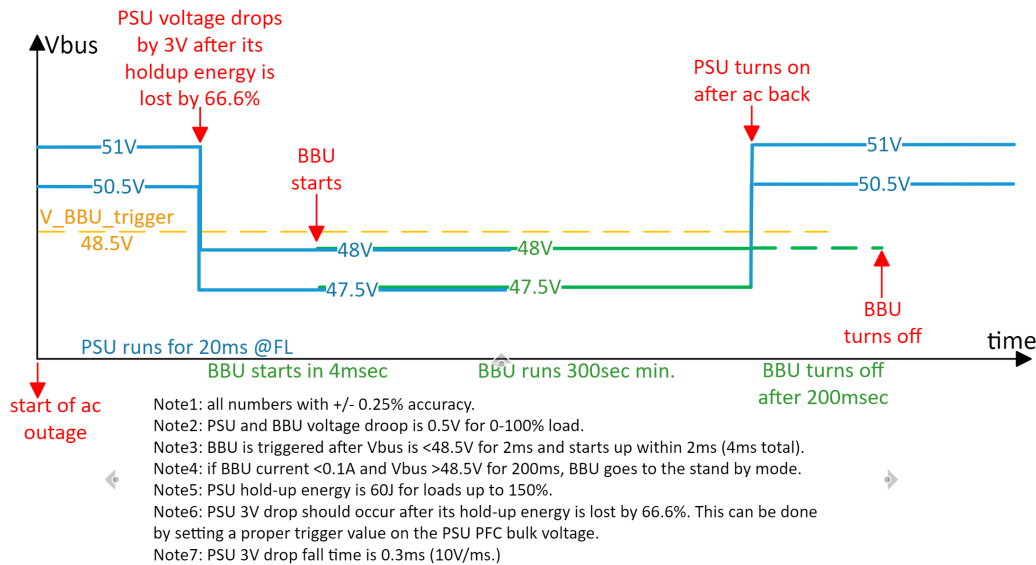

Per the scheme above, for the worst case that AC outage and pulse power happens at the same time (and pulse power remains constantly), PSU will transition to BBU seamlessly as calculated in the table below.

Load Power	Holdup Time (ms)	Time Before 3V Drop (ms)	Remaining Time After 3V Drop (ms)
100%	20.00	10.0	9.0
110%	18.18	9.1	8.1
120%	16.67	8.3	7.3
130%	15.38	7.7	6.7
140%	14.29	7.1	6.1
150%	13.33	6.7	5.7

In case that AC voltage is available, but constant overload of up to 150% happens, PSUs will drop voltage by 3 V per the scheme above and share power with BBUs. PSUs will retry to sync together and increase the voltage once every 10 s.

PROTECTION

Input Over Current Protection

The rectifier will incorporate primary fusing on both phase and return lines for input over-current protection to meet product safety requirements. Fuses shall be selected to prevent nuisance trips. Fuse may be internal to unit and need not be user serviceable. AC inrush current will not cause the fuse to blow under any conditions. No rectifier operating condition will cause the fuse to blow unless a component in the rectifier has failed. This includes DC output overload and short-circuit conditions. Fuse will be approved by UL for an interrupt rating of at least 14 kA for 10 ms.

PSU fuse will be in coordination with datacenter Tapbox breaker curve as given below.

NEC breakers are 20 and 30 A (two ac feeds go to the power shelf – one PSU per input ac phase feed).

IEC breaker is normally 32 A (one ac feed goes to the power shelf – two PSUs per input ac phase feed). (Ignore 16A breaker.)

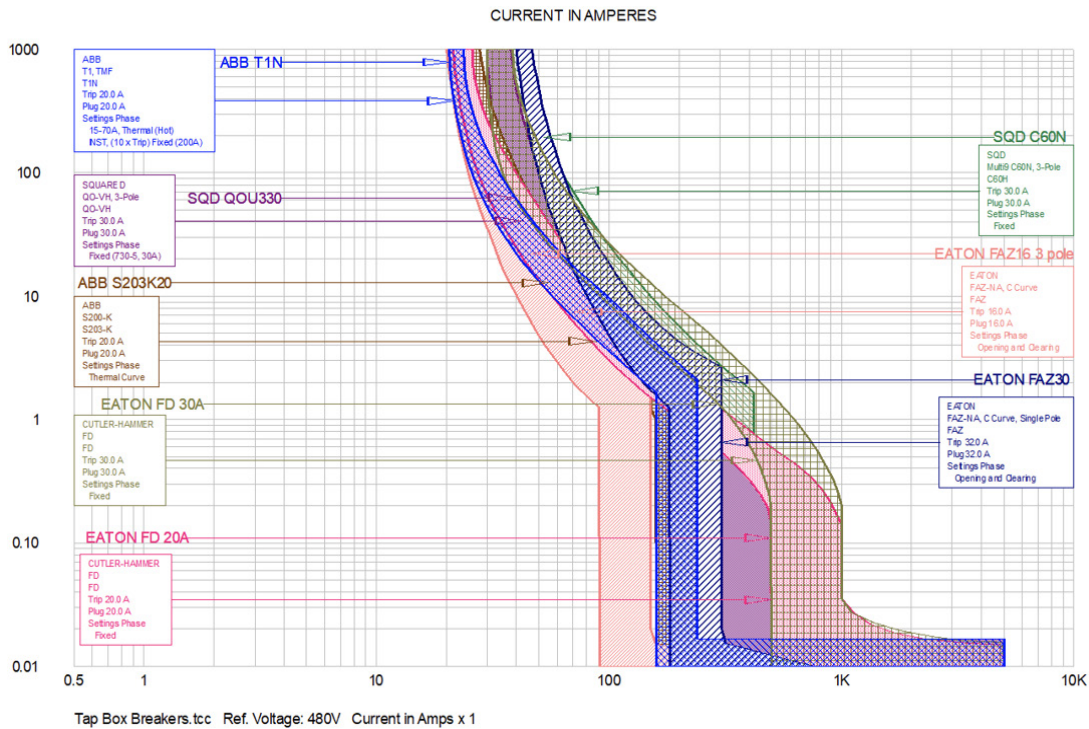

Input Over Voltage Protection

The rectifier will shut down for DC output voltage exceeding 52.5V and the reacting time not exceed 200 ms. For DC output voltage will never exceed 54 V (fast OVP).

Output Power/ Current Protection

If a PSU is overloaded higher than the values listed below, it shall immediately reduce its voltage by 3 V and wait for 5mS (to give enough time for BBU to take over). If overload is still there, PSU can shut down. After an overload fault, PSUs shall retry 5 times to sync together and turn on once every 10 S.

- Average power more than 3.3 kW for 10 S.
- Average power more than 3.6 kW for 100 mS.
- Repetitive pulse power more than the pulse power envelope specified (up to 150% load).
- Single pulse power more than holdup time at the overload condition (up to 150% load).

PROTECTION

Output Short Protection

The rectifier includes short-circuit protection to protect the rectifier and attached load in the case of an output short-circuit or other output overload condition.

If the rectifier voltage is lower than 10 V (short circuit condition), the rectifier shuts off immediately. No component damage. The protection will be implemented with a hiccup mode. it tries to restart 5 times (2 S off, 200 mS on) and then locks out.

Over Temperature Protection

The rectifier includes over temperature protection for both ambient over temperature and internal thermal temperature to protect the rectifier. The rectifier will shut down under over temperature condition and recover after certain period after the over temperature condition is removed.

The OTP circuit will incorporate built in hysteresis such that the power supply does not oscillate on and off due to temperature recovering condition. The OTP event will be reported as a fault condition.

TIMING

Random Timer and Synchronization

Under any conditions of dissipative load, capacitive load, temperature, with or without backup voltage connected to the PSU,

Max time for PSU to be “power-up ready” after AC voltage starts is 2.5 S.

After “power-up ready”:

When there is no DC voltage on the bus (first AC turn on) the power shelf will be randomized with 0 to 2 S window to give each power shelf a random turn-on time (six PSUs turn-on is synchronized).

When there is DC voltage on the bus higher than 44 V for 0.1 second (BBU is discharging), the power shelf will be randomized with 0 to 5.5 seconds window to give each power shelf a random turn-on time (six PSU turn-on is synchronized).

The power shelf will turn on with only 1 PSU inserted into any slot.

Note: The random numbers above will be dynamically generated immediately after each AC recycle, and not generated one time and then stored in the EEPROM for future usages.

Item	Description	Min	Max	Unit
T_power-up_ready	Time for PSU to be power-up ready	1.0	2.5	s
T_random_noBBU	0 to 2 seconds initial turn on random delay without BBU discharging	0	2.0	s
Ton_noBBU	Time 51 VDC turns on after shelf receives AC input without BBU discharging.	1.0	4.5	s
T_random_BBU	0 to 5.7 seconds turn on random delay after BBU discharging	0	5.5	s
Ton_BBU	Time 51 VDC turns on after shelf receives AC input with BBU discharging.	1.0	8.0	s
Tsync	After all PSUs in the shelf are ready to start till when 51 VDC will start	2.0	5.0	ms
Tmax_ON_noBBU	Max PSU turn-on time without BBU in case of sync failure	4.0	5.5	s
Tmax_ON_BBU	Max PSU turn-on time with BBU in case of sync failure	7.5	9.0	s

SYNC PROCESS

Each PSU sets its uC digital output signal (Do_SyncReady_L) to low when the PSU is ready to turn on the output.

Only PSU in SLOT #1 generates random timer and set Do_SyncReady_L to low when ready and random timer is finished.

The PSUs will turn on the output when the uC digital input sync signal (DI_Sync_H) is high.

If DI_Sync_H kept stuck low for 1 s more than the max random timer limit (which is 2 s without BBU and 5.7 s with BBU), the PSU will turn on immediately.

If PSU1 is not installed or its Do_SyncReady_L stuck low, the other PSUs will turn on when the DI_Sync_H is high. In this case random timer doesn't exist.

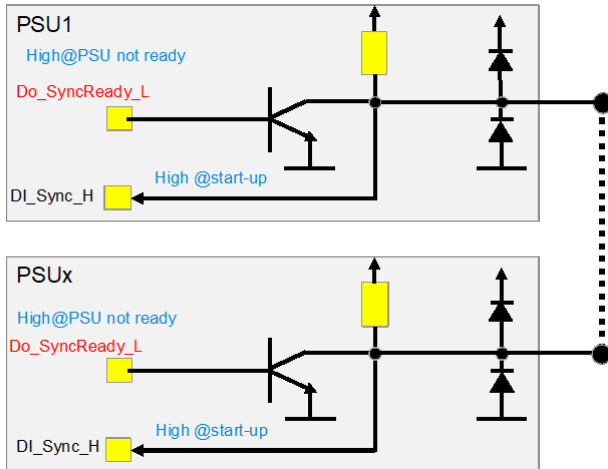

CONTROL AND MONITORING SSIGNAK

The Power shelf includes a slot for a power shelf management controller (PMC) to monitor and control various rectifier parameters. The PMC is connected to rack management controller or facility level monitoring through a monitoring & control interface.

If the PMC fails or is not provided, the power system is able to operate normally. The PMC is powered from the 48V bus directly.

COMMUNICATIONS

The rectifiers can communicate on PMBus (up to 100 kbps) and ModBus (up to 115 kbps).

At default, Modbus is active and PMBus is hardware only. Contact AdvancedEnergy to switch to PMBus communication.

The software interface is operational when the AC is present or when the DC output bus is powered up by other power sources. The software provide below functions:

Fault conditions

- . Last power failure event
- . Rectifier failure

Read:

- . Voltage in
- . Current in
- . Voltage out
- . Current out
- . Temperatures
- . Fan speeds
- . Power out
- . Power in
- . Position
- . Serial Number
- . Manufacturer part number
- . Hardware revision
- . Firmware revision

Write:

- . Clear faults

Upgrades:

- . Upgrade firmware image (s)

Firmware Upgrade

The interface shall allow the user to re-flash firmware on the device. Firmware upgrade shall result in no power interruption on the shelf level (the unit being upgrade can go offline.) Upgrades can be done 1 rectifier at a time.

The PSU FW shall maintain regulation on the output during Send, Install and verification of the new FW, and only require a soft reset (that may reset the output for a short period in a few seconds)

COMMUNICATIONS

Reporting Accuracy

Accurate reporting of input power (power factor, input current, input current harmonics and voltage) and output power (output current and voltage) readings shall be reported via communication system at all rated voltage.

The accuracy will be maintained across the operating temperature range and between 200 VAC and 305 VAC.

AC Input Power	<10%	±25W
	10% to 20%	<±5%
	20% to 100%	<±3%
AC Input Current	<10%	±0.5A
	10% to 20%	<±2%
	20% to 100%	<±1%
AC Input Current THD	<10%	<±10%
	10% to 20%	<±2%
	20% to 100%	<±1%
Power Factor	<10%	±0.1
	10 to 20%	±0.02
	20 to 100%	±0.01
AC Input Voltage	0 to 100%	±1%
Output Voltage	0 to 100%	±0.5%
Output Current	10 to 20%	±10%
	10 to 20%	±5%
	20 to 100%	±1%
Output Power	<10%	±25W
	10 to 20%	<3%
	20 to 100%	<2%

BLACKBOX FUNCTION

For the following section please refer to the latest Communication Specification for detailed information.

The black box function store key important data to be used when a fault occurs.

- . Store data in memory and can withstand several read/write cycles
- . PSU can store failure data before the PSU turns off/fails even in catastrophic failure events both on primary and secondary side. Hold up time of the blackbox microcontroller can store all the information and then shutdown.
- . Last 4 events stored in memory.
- . AC input current, AC input voltage, Input Power, Power factor, iTHD, DC output voltage, DC output current,
- . Temperature readings, fan Speed, input voltage, output voltage, bulk voltage, various error codes from all the different converters (OTP, OVP, OCP, UVP), and warnings.
- . BBU signals at time of failure (fail, charge_enable, BBU voltage, etc)
- . Total run time of PSU
- . Run time since last turn on
- . Real time stamping
- . Number of AC power cycles
- . Number of AC outages (can be determined by going into backup without counting the battery test conditions)

Power supply event data is saved to the Black Box for the following events that :

Any events that caused the Main Output to shut down:

- . Main Output over voltage fault
- . Main Output under voltage fault
- . Main Output over current fault
- . Main Output short circuit fault
- . Fan failure
- . Over temperature fault

Any events that caused the AC input to be bad:

- . AC Input under voltage fault
- . AC Input over voltage fault
- . AC Input out of range frequency fault

ENVIRONMENTAL SPECIFICATIONS

Temperature range	Operational: -5°C to +45°C; Non-operational: -40°C to +85°C
Humidity	Operational: 10% to 90% non-condensing; Non-operational: 5% to 93% non-condensing
Altitude	Operational: 3050 m; Non-operational: 12000 m
Shock	EN 60068-2-6 and 60068-2-27 12g Non-Operating / 6g Operating
Vibration	EN 60068-2-6 and 60068-2-27 1g Non-Operating / 0.5g Operating
Fan noise	< 85 dBA, 100% load

Thermal

Airflow Direction:

Front-to-back

Fan Speed Control:

The fan speed varies depending on ambient temperature and load and is optimized to maintain a temperature difference of 22°F nominally across 30 to 85% load range and up to 35°C inlet/ambient and 3050 m (10,000 ft) above sea-level. The benefit is reduced fan power usage.

System back-pressure:

Front-to-back airflow maintain for system backpressure up to minimum 0.3 inches of water.

Fan Failure:

If a fan fails, the rectifier will indicate the failure with a signal that will be reported via software as well as an LED indicator on the front panel. The rectifier will not shut down because of a failed fan and will only shut down if there is a fault, ie. over-temperature fault.

Rectifier Thermal Monitoring:

Inlet temperature, exhaust temperature, fan speed and fan fail signals are reported via communications. See Communications Section for details.

MECHANICAL - PSU

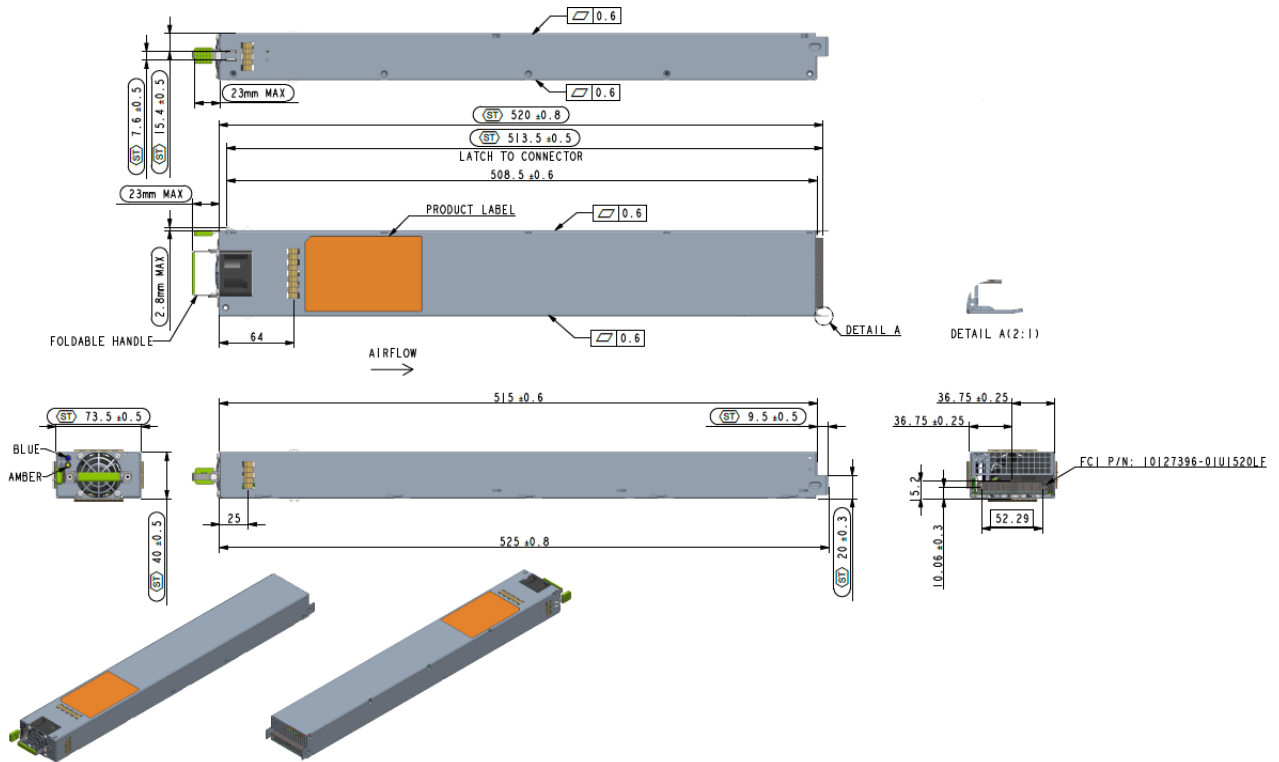

MECHANICAL - POWER SHELF

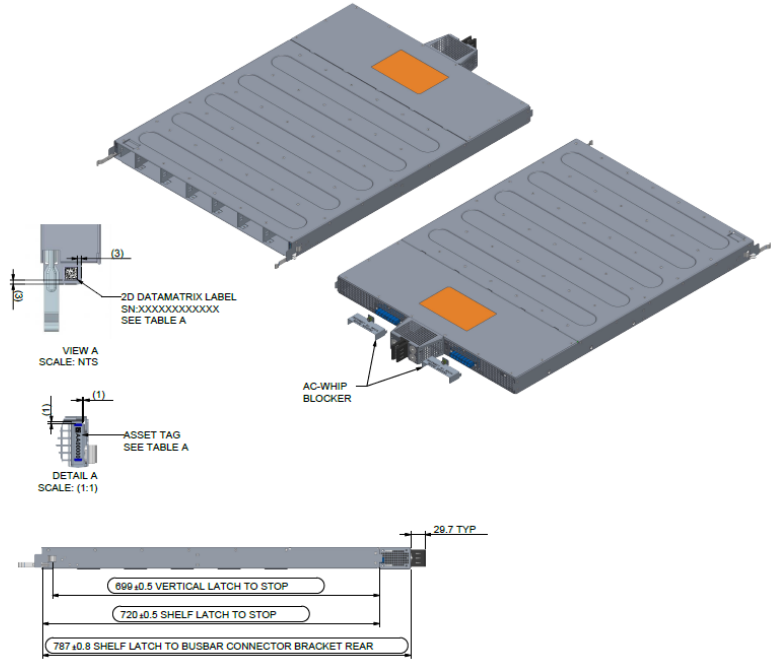
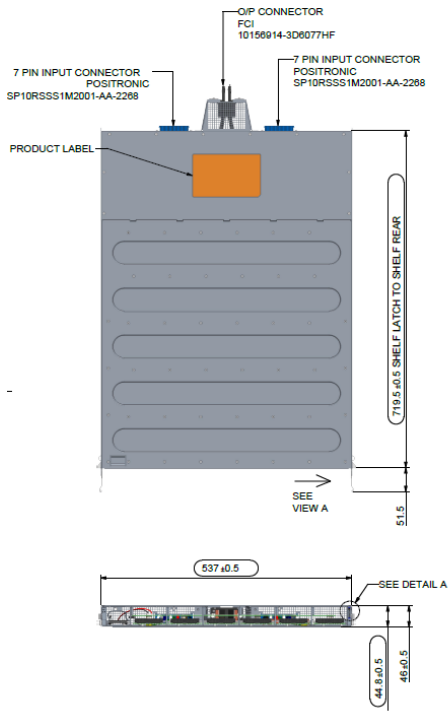

MECHANICAL - PMI

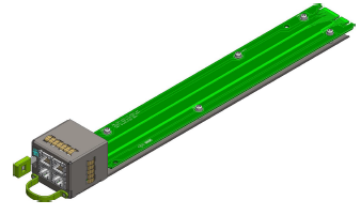

3D VIEW

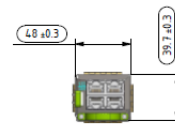
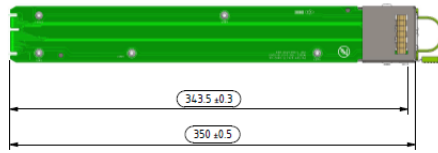

RJ45 P/N: 2041376-4 (ITE CONNECTIVITY),
RJSAE-J304-04 (AMPHENOL)

PIN ASSIGNMENT

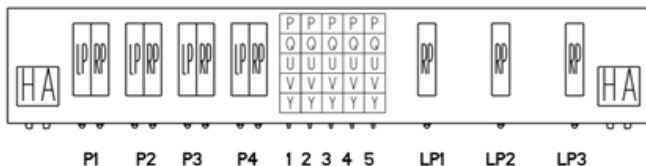

PSU connector pinout

Pin	Name	Description
P1 & P2	48V positive	
P3 & P4	48V return	
LP1	Earth	
LP2	AC phase	
LP3	AC phase	
P1	PSU_A0	Address 0 - PSU ID A0, Internal pull up 10k to 3.3V
P2	PSU_A1	Address 1 - PSU ID A1, Internal pull up 10k to 3.3V
P3	PSU_A2	Address 2 - PSU ID A2, Internal pull up 10k to 3.3V
P4	PSU_A3	Address 3 - PSU ID A3, Internal pull up 10k to 3.3V
P5		
Q1	Ground	
Q2	Alert	Logic "low"= Fault or Warning, Logic "High"=OK, Internal pull up 10k to 3.3V PSU Alert
Q3	Reset_Latch_Fault	Logic "high" for 1 to 2s = clear faults and start PSU to operate if not working due to a fault
Q4	RS485_addr0	Internal pull up 10k to 3.3V
Q5	RS485_addr1	Internal pull up 10k to 3.3V
U1	RS485_addr2	Internal pull up 10k to 3.3V
U2	BKP	Internal pull up 10k to 3.3V, not used
U3	PSKILL (Short Pin)	Logic "Low"= Output Turn on, Logic "High"= Output Turn off Quick shut down Output, mitigate hot unplug arcing. Internal pull up 10k to 3.3V
U4	RS485A	
U5	RS485B	
V1	Ground	
V2	I2C_SDA	I2C Data
V3	I2C_SCL	I2C Clock
V4	Ground	I2C ground
V5	PLS (power loss siren)	Logic "Low"= Input is not OK for 45Sec, Logic "High"= Input is OK Internal pull up 10k to 3.3V. All PSUs ORed together
Y1	ISHARE	Main Output current share bus
Y2	SYNC_STOP	Synchronizing turn off main output (no use case currently)
Y3	SYNC_START	Synchronizing turn-on main output, Internal pull up 10k to 3.3V
Y4	VOUT_SEL	Logic "Low"= Set Output 48V, Logic "High"=Set Output 51V, Internal pull up 10k to 3.3V, Default Output is 51V
Y5	Ground	

Note: P3, P4, and LP1 connect first. U3 is short pin.

MATING CONNECTOR INFORMATION

Device	Connector	Mating Connector	Description
PSU	FCI: 10127396-01U1520LF (PwrBlade ULTRA HD)	FCI: 1027400-01U1520LF (PwrBlade ULTRA HD)	I/O Connector

LED



The PSU has a single blue and single amber LED mounted near the PSU handle for accessibility. Following are power supply LED states:

LED	Status	Description
Blue LED	Blinking Blue @ 4 Hz frequency	Sync Start State, PSU is ready to turn on its output and awaiting the sync Start signal
	Solid Blue	51 V is ON and available
	Off	51 V output off
Amber LED	Blinking Amber @ 4 Hz frequency:	Bootloading
	Solid Amber	Primary/Secondary/Fan/bootloading Failure and/or loss of DC output (refer to PSU PMbus registers for specific failures)
	Off	fault NOT present/condition 1 and 2 are false

Note 1 - Toggling AC input power will reset the solid/blinking amber fault light but will come up again if faults re-occur.

Note 2 - Only one of the 3 conditions per LED will be applied at all time.

ORDERING INFORMATION

Model	Input	Output	Description
700-015234-0100	1 Phase AC, 180 to 305 VAC, 50 to 60 Hz	50 V  60 A	ACDC-ORV3-3000 W, ORV3 PSU
700-015746-0100	3 Phase AC, 200/480 V, 50 to 60 Hz	50 V  300 A	ACDC-ORV3-1OU-18 kW, ORV3 Power Shelf - Single Whip
700-015235-0100 ¹	3 Phase AC, 200/480 V, 50 to 60 Hz	50 V  300 A	ACDC-ORV3-1OU-18 kW, ORV3 Power Shelf - Dual Whip
700-015718-0100			PMI

Note 1 - Shelves are related products (not covered by this data sheet). Refer to ORV3 power shelf data sheet.



For international contact information,
visit advancedenergy.com.

powersales@aei.com (Sales Support)
productsupport.ep@aei.com (Technical Support)
+1 888 412 7832

ABOUT ADVANCED ENERGY

Advanced Energy (AE) has devoted more than three decades to perfecting power for its global customers. AE designs and manufactures highly engineered, precision power conversion, measurement and control solutions for mission-critical applications and processes.

Our products enable customer innovation in complex applications for a wide range of industries including semiconductor equipment, industrial, manufacturing, telecommunications, data center computing, and medical. With deep applications know-how and responsive service and support across the globe, we build collaborative partnerships to meet rapid technological developments, propel growth for our customers, and innovate the future of power.

PRECISION | POWER | PERFORMANCE

Specifications are subject to change without notice. Not responsible for errors or omissions. ©2022 Advanced Energy Industries, Inc. All rights reserved. Advanced Energy®, AE® and Artesyn™ are U.S. trademarks of Advanced Energy Industries, Inc.