

ARTESYN AYA 3W SERIES

DC/DC Converter



PRODUCT DESCRIPTION

Advanced Energy's Artesyn AYA 3W series contains single and dual output DC/DC converter modules with industry standard pin configuration. All models feature ultra-wide 2:1 input range with excellent output voltage regulation. The AYA 3W series can deliver up to 3W output power from the single or dual output module with high 87% typical efficiency and excellent thermal performance over an operating ambient temperature range of -40°C ~ $+85^{\circ}\text{C}$ with derating.

SPECIAL FEATURES

- Package size 0.55" x 0.55" x 0.31"
- High efficiency up to 87%
- I/O isolation voltage 1500Vdc
- Ultra-wide 2:1 input range
- Operating temperature range: -40°C to $+85^{\circ}\text{C}$ (with derating)
- 3 Years product warranty

SAFETY

- cUL/UL 60950-1
- IEC/EN 60950-1
- CE Mark

TYPICAL APPLICATIONS

- Industrial

AT A GLANCE

Total Power

3 Watts

Input Voltage

4.5 to 1.0 Vdc

9 to 18 Vdc

18 to 36 Vdc

36 to 75 Vdc

of Outputs

Single / Dual



Model Numbers

Part Number	Input Voltage	Output Voltage	Output Current	Efficiency
AYA01F05-L	4.5 - 10Vdc	3.3Vdc	0.6A	79%
AYA01A05-L	4.5 - 10Vdc	5Vdc	0.6A	81%
AYA01B05-L	4.5 - 10Vdc	12Vdc	0.25A	85%
AYA01C05-L	4.5 - 10Vdc	15Vdc	0.2A	85%
AYA01AA05-L	4.5 - 10Vdc	±5Vdc	±0.3A	82%
AYA01BB05-L	4.5 - 10Vdc	±12Vdc	±0.125A	84%
AYA01CC05-L	4.5 - 10Vdc	±15Vdc	±0.1A	85%
AYA01F12-L	9 - 18Vdc	3.3Vdc	0.6A	80%
AYA01A12-L	9 - 18Vdc	5Vdc	0.6A	83%
AYA01B12-L	9 - 18Vdc	12Vdc	0.25A	87%
AYA01C12-L	9 - 18Vdc	15Vdc	0.2A	87%
AYA01AA12-L	9 - 18Vdc	±5Vdc	±0.3A	84%
AYA01BB12-L	9 - 18Vdc	±12Vdc	±0.125A	86%
AYA01CC12-L	9 - 18Vdc	±15Vdc	±0.1A	87%
AYA01F24-L	18 - 36Vdc	3.3Vdc	0.6A	80%
AYA01A24-L	18 - 36Vdc	5Vdc	0.6A	83%
AYA01B24-L	18 - 36Vdc	12Vdc	0.25A	87%
AYA01C24-L	18 - 36Vdc	15Vdc	0.2A	87%
AYA01AA24-L	18 - 36Vdc	±5Vdc	±0.3A	84%
AYA01BB24-L	18 - 36Vdc	±12Vdc	±0.125A	86%
AYA01CC24-L	18 - 36Vdc	±15Vdc	±0.1A	87%
AYA01F48-L	36 - 75Vdc	3.3Vdc	0.6A	79%
AYA01A48-L	36 - 75Vdc	5Vdc	0.6A	82%
AYA01B48-L	36 - 75Vdc	12Vdc	0.25A	86%
AYA01C48-L	36 - 75Vdc	15Vdc	0.2A	86%
AYA01AA48-L	36 - 75Vdc	±5Vdc	±0.3A	82%
AYA01BB48-L	36 - 75Vdc	±12Vdc	±0.125A	85%
AYA01CC48-L	36 - 75Vdc	±15Vdc	±0.1A	85%

Electrical Specifications

Absolute Maximum Ratings

Stress in excess of those listed in the “Absolute Maximum Ratings” may cause permanent damage to the power supply. These are stress ratings only and functional operation of the unit is not implied at these or any other conditions above those given in the operational sections of this TRN. Exposure to any absolute maximum rated condition for extended periods may adversely affect the power supply’s reliability.

Table 1. Absolute Maximum Ratings						
Parameter	Model	Symbol	Min	Typ	Max	Unit
Input Voltage Operating -Continuous	5V input models	$V_{IN,DC}$	4.5	-	10	Vdc
	12V input models		9	-	18	Vdc
	24V input models		18	-	36	Vdc
	48V input models		36	-	75	Vdc
Maximum Output Power	All models	$P_{O,max}$	-	-	3	W
Isolation Voltage	All models		1500	-	-	Vdc
			1800	-	-	Vdc
Isolation Resistance 500Vdc	All models		1000	-	-	Mohm
Operating Ambient Temperature	All models	T_A	-40	-	+85 ¹	°C
Operating Case Temperature	All models	T_{CASE}	-	-	+95	°C
Storage Temperature	All models	T_{STG}	-50	-	+125	°C
Humidity (non-condensing)	Operating	All models	-	-	95	%
	Non-operating	All models	-	-	95	%
Cooling	All models	Natural Convection ²				
Lead Temperature	All models		-	-	260 ³	°C

Note 1 – Please refer to derating curve when operating ambient temperature is 70°C ~ +85°C

Note 2 – The Natural Convection is about 20 LFM, but not equal to still air (0 LFM)

Note 3 – 1.5mm from case for 10 Sec

Electrical Specifications

Input Specifications

Table 2. Input Specifications							
Parameter		Condition	Symbol	Min	Typ	Max	Unit
Operating Input Voltage, DC	5V input models	All	$V_{IN,DC}$	4.5	5	10	Vdc
	12V input models			9	12	18	
	24V input models			18	24	36	
	48V input models			36	48	75	
Input Surge Voltage	5V input models	1 Sec, max	$V_{IN,surge}$	-0.7	-	12	Vdc
	12V input models			-0.7	-	25	
	24V input models			-0.7	-	50	
	48V input models			-0.7	-	100	
Start-up Threshold Voltage	5V input models	All	$V_{IN,ON}$	-	-	4.5	Vdc
	12V input models			-	-	9	
	24V input models			-	-	18	
	48V input models			-	-	36	
Input Current	AYA01F05-L	$V_{IN,DC}=V_{IN,nom}$ $I_O=I_{O,max}$	$I_{IN,full\ load}$	-	501	-	mA
	AYA01A05-L			-	741	-	
	AYA01B05-L			-	706	-	
	AYA01C05-L			-	706	-	
	AYA01AA05-L			-	732	-	
	AYA01BB05-L			-	714	-	
	AYA01CC05-L			-	706	-	
	AYA01F12-L			-	206	-	
	AYA01A12-L			-	301	-	
	AYA01B12-L			-	287	-	
	AYA01C12-L			-	287	-	
	AYA01AA12-L			-	298	-	
	AYA01BB12-L			-	291	-	
	AYA01CC12-L			-	287	-	
	AYA01F24-L			-	103	-	
	AYA01A24-L			-	151	-	
	AYA01B24-L			-	144	-	
	AYA01C24-L			-	144	-	
	AYA01AA24-L			-	149	-	
	AYA01BB24-L			-	145	-	
	AYA01CC24-L			-	144	-	
	AYA01F48-L			-	52	-	
	AYA01A48-L			-	76	-	
	AYA01B48-L			-	73	-	
	AYA01C48-L			-	73	-	
	AYA01AA48-L			-	76	-	
	AYA01BB48-L			-	74	-	
AYA01CC48-L	-	74	-				

Electrical Specifications

Input Specifications

Table 2. Input Specifications cont							
Parameter		Condition	Symbol	Min	Typ	Max	Unit
No Load Input Current	5V input Models	$V_{IN,DC}=V_{IN,nom}$ $I_O = 0A$	$I_{IN,no-load}$	-	45	-	mA
	12V input Models			-	27	-	
	24V input Models			-	16	-	
	48V input Models			-	10	-	
Efficiency	AYA01F05-L	$V_{IN,DC}=V_{IN,nom}$ $I_O=I_{O,max}$ $T_A = 25\text{ }^\circ\text{C}$	η	-	79	-	%
	AYA01A05-L			-	81	-	
	AYA01B05-L			-	85	-	
	AYA01C05-L			-	85	-	
	AYA01AA05-L			-	82	-	
	AYA01BB05-L			-	84	-	
	AYA01CC05-L			-	85	-	
	AYA01F12-L			-	80	-	
	AYA01A12-L			-	83	-	
	AYA01B12-L			-	87	-	
	AYA01C12-L			-	87	-	
	AYA01AA12-L			-	84	-	
	AYA01BB12-L			-	86	-	
	AYA01CC12-L			-	87	-	
	AYA01F24-L			-	80	-	
	AYA01A24-L			-	83	-	
	AYA01B24-L			-	87	-	
	AYA01C24-L			-	87	-	
	AYA01AA24-L			-	84	-	
	AYA01BB24-L			-	86	-	
AYA01CC24-L	-	87	-				
AYA01F48-L	-	79	-				
AYA01A48-L	-	82	-				
AYA01B48-L	-	86	-				
AYA01C48-L	-	86	-				
AYA01AA48-L	-	82	-				
AYA01BB48-L	-	85	-				
AYA01CC48-L	-	85	-				
Short Circuit Input Power		All		-	-	0.5	W
Internal Filter			Internal Capacitor				

Electrical Specifications

Output Specifications

Table 3. Output Specifications							
Parameter	Condition	Symbol	Min	Typ	Max	Unit	
Output Voltage Set-Point	$V_{IN,DC} = V_{IN,nom}$ $I_O = I_{O,max}$ $T_A = 25\text{ }^\circ\text{C}$	$\pm V_{O,set}$	-	-	1.5	%	
Output Ripple, pk-pk	20MHz bandwidth, measured with a 1uF MLCC and a 10uF Tantalum Capacitor	V_O	-	70	-	mV	
Line Regulation	$V_{IN,DC} = V_{IN,min}$ to $V_{IN,max}$ $I_O = I_{O,max}$	$\pm\%V_O$	-	-	0.2	%	
Load Regulation	$V_{IN,DC} = V_{IN,nom}$ $I_O = 0$ to $100\% I_{O,max}$	$\pm\%V_O$	-	-	1.0	%	
V_O Dynamic Response	Peak Deviation Settling Time	$V_{IN,DC} = V_{IN,nom}$ 25% load change, slew rate = 1A/uS	$\pm\%V_O$	-	3	5	% uSec
				-	250	500	
V_O Load Capacitance	For each output		-	-	100	uF	
Output Current	AYA01F05-L	Convection cooling	I_O	-	-	0.6	A
	AYA01A05-L			-	-	0.6	
	AYA01B05-L			-	-	0.25	
	AYA01C05-L			-	-	0.2	
	AYA01AA05-L			-	-	± 0.3	
	AYA01BB05-L			-	-	± 0.125	
	AYA01CC05-L			-	-	± 0.1	
	AYA01F12-L			-	-	0.6	
	AYA01A12-L			-	-	0.6	
	AYA01B12-L			-	-	0.25	
	AYA01C12-L			-	-	0.2	
	AYA01AA12-L			-	-	± 0.3	
	AYA01BB12-L			-	-	± 0.125	
	AYA01CC12-L			-	-	± 0.1	
	AYA01F24-L			-	-	0.6	
	AYA01A24-L			-	-	0.6	
	AYA01B24-L			-	-	0.25	
	AYA01C24-L			-	-	0.2	
	AYA01AA24-L			-	-	± 0.3	
	AYA01BB24-L			-	-	± 0.125	
	AYA01CC24-L			-	-	± 0.1	
	AYA01F48-L			-	-	0.6	
	AYA01A48-L			-	-	0.6	
	AYA01B48-L			-	-	0.25	
AYA01C48-L	-	-	0.2				
AYA01AA48-L	-	-	± 0.3				
AYA01BB48-L	-	-	± 0.125				
AYA01CC48-L	-	-	± 0.1				

Electrical Specifications

Output Specifications

Table 3. Output Specifications con't						
Parameter	Condition	Symbol	Min	Typ	Max	Unit
Temperature Coefficient	All	$\pm\%/^{\circ}\text{C}$	-	0.01	0.02	%
Switching Frequency ¹	All	f_{sw}	100	-	-	KHz
Output Over Current Protection	Foldback		-	170	-	% $I_{\text{O,max}}$
Output Short Circuit Protection	All		Continuous, Auotmatic Recovery			

Note 1: See the detailed switching frequency under different condition in the application note

Electrical Specifications

AYA01F05-L Performance Curves

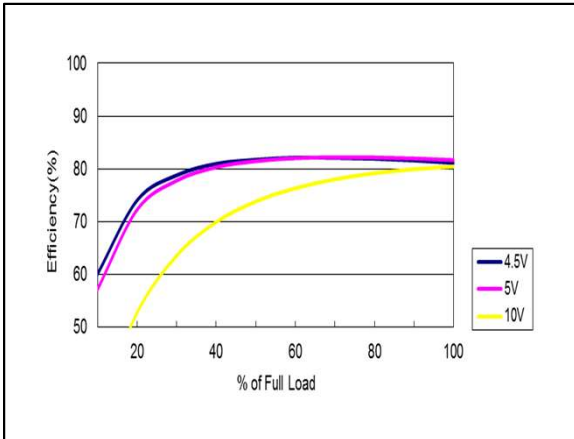

Figure 1: AYA01F05-L Efficiency Versus Output Current Curve
 Vin = 4.5 to 10Vdc Load: Io = 0 to 0.6A

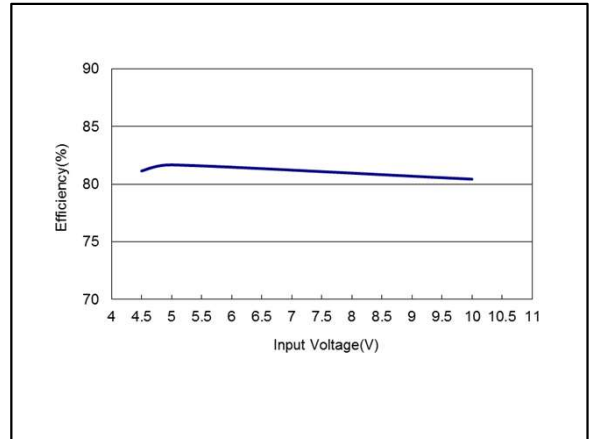

Figure 2: AYA01F05-L Efficiency Versus Input Voltage Curve
 Vin = 4.5 to 10Vdc Load: Io = 0.6A

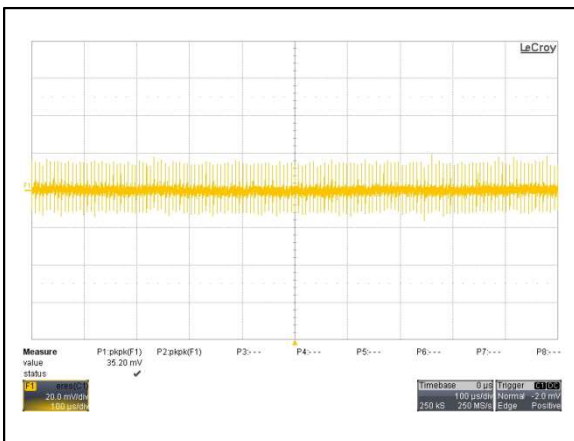

Figure 3: AYA01F05-L Ripple and Noise Measurement
 Vin = 5Vdc Load: Io = 0.6A
 Ch 1: Vo

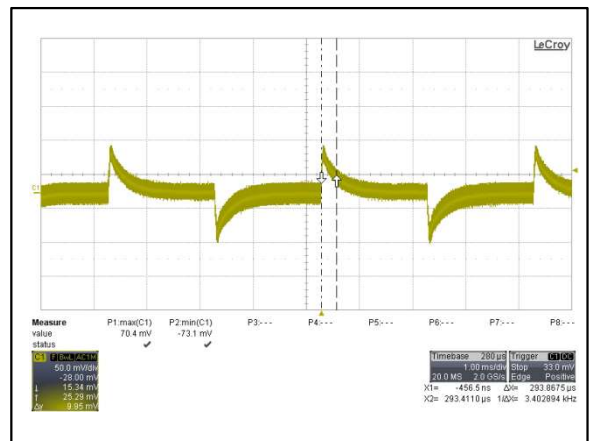

Figure 4: AYA01F05-L Transient Response
 Vin = 5Vdc Load: Io = 100% to 75% load change
 Ch 1: Vo

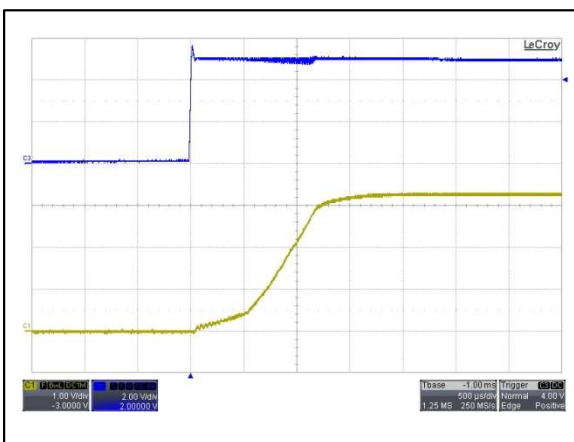

Figure 5: AYA01F05-L Output Voltage Startup Characteristic by Vin
 Vin = 5Vdc Load: Io = 0.6A
 Ch 3: Vin Ch 1: Vo

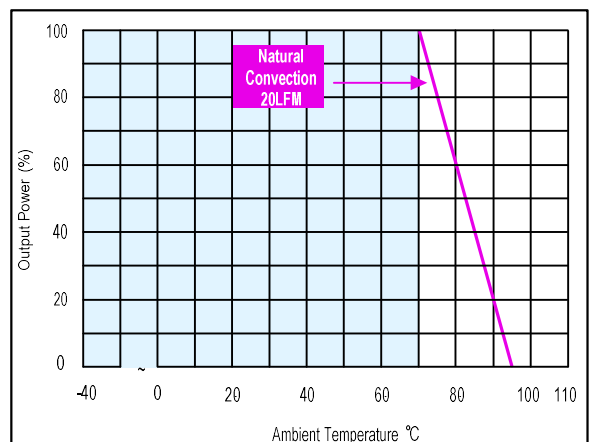

Figure 6: AYA01F05-L Derating Curve
 Vin = 5Vdc

Electrical Specifications

AYA01A05-L Performance Curves

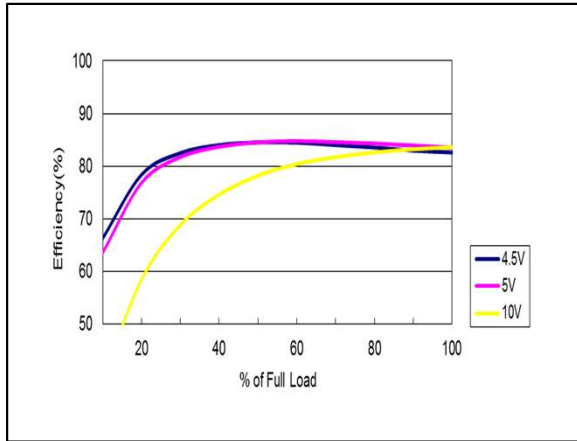

Figure 7: AYA01A05-L Efficiency Versus Output Current Curve
 Vin = 4.5 to 10Vdc Load: Io = 0 to 0.6A

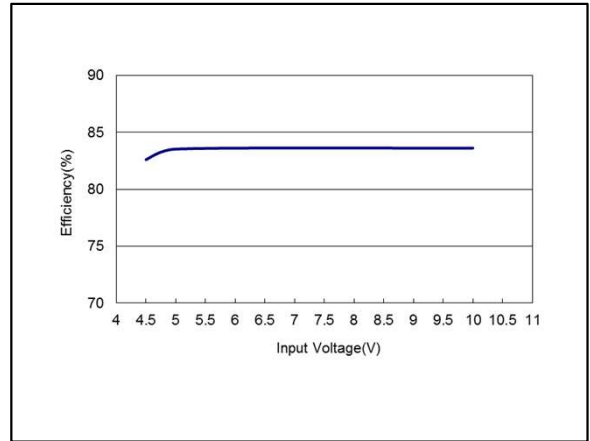

Figure 8: AYA01A05-L Efficiency Versus Input Voltage Curve
 Vin = 4.5 to 10Vdc Load: Io = 0.6A

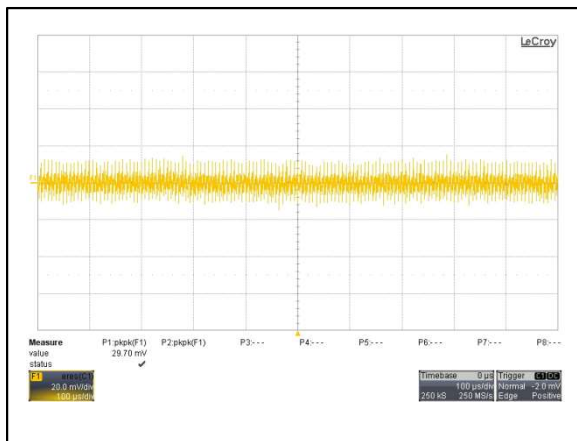

Figure 9: AYA01A05-L Ripple and Noise Measurement
 Vin = 5Vdc Load: Io = 0.6A
 Ch 1: Vo

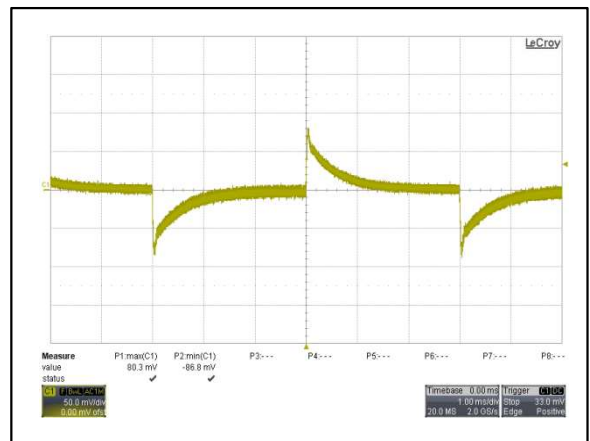

Figure 10: AYA01A05-L Transient Response
 Vin = 5Vdc Load: Io = 100% to 75% load change
 Ch 1: Vo

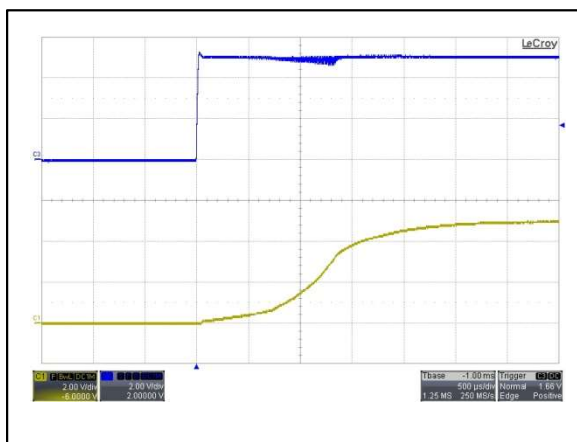

Figure 11: AYA01A05-L Output Voltage Startup Characteristic by Vin
 Vin = 5Vdc Load: Io = 0.6A
 Ch 3: Vin Ch 1: Vo

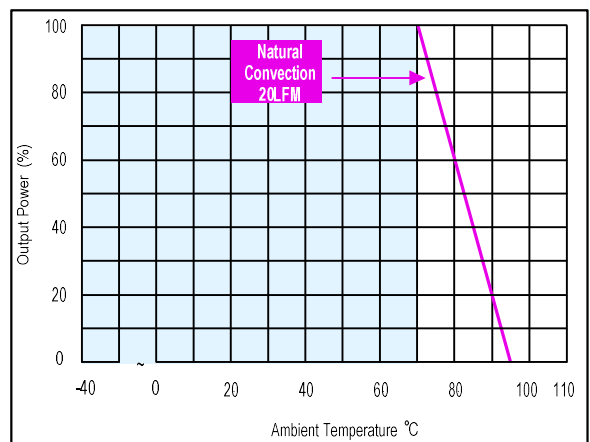

Figure 12: AYA01A05-L Derating Curve
 Vin = 5Vdc

Electrical Specifications

AYA01B05-L Performance Curves

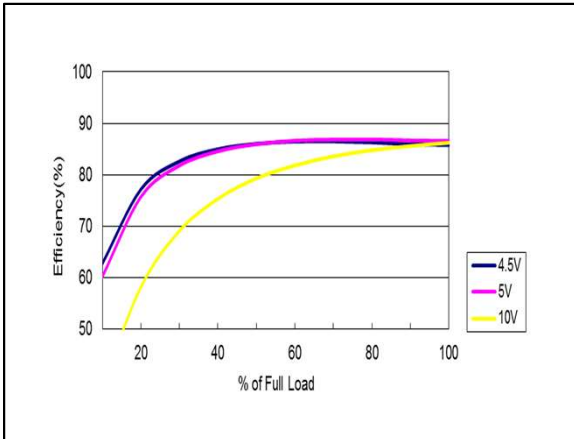

Figure 13: AYA01B05-L Efficiency Versus Output Current Curve
 Vin = 4.5 to 10Vdc Load: Io = 0 to 0.25A

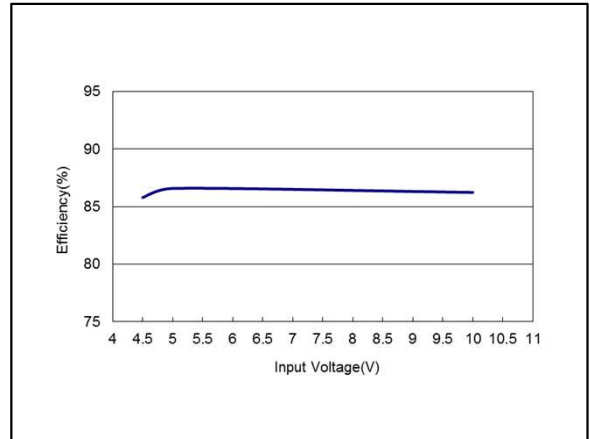

Figure 14: AYA01B05-L Efficiency Versus Input Voltage Curve
 Vin = 4.5 to 10Vdc Load: Io = 0.25A

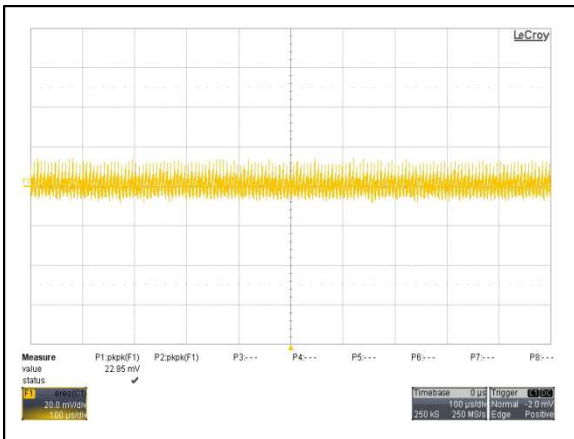

Figure 15: AYA01B05-L Ripple and Noise Measurement
 Vin = 5Vdc Load: Io = 0.25A
 Ch 1: Vo

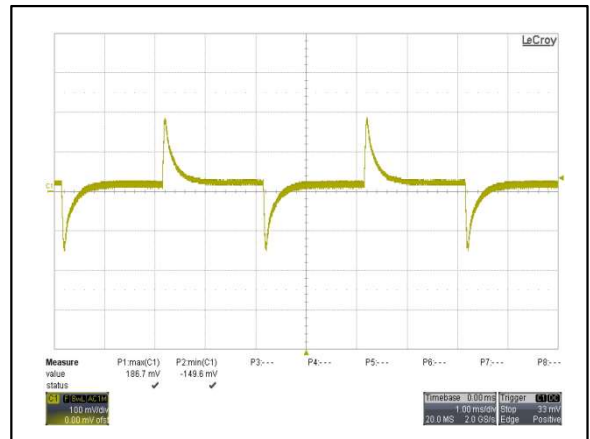

Figure 16: AYA01B05-L Transient Response
 Vin = 5Vdc Load: Io = 100% to 75% load change
 Ch 1: Vo

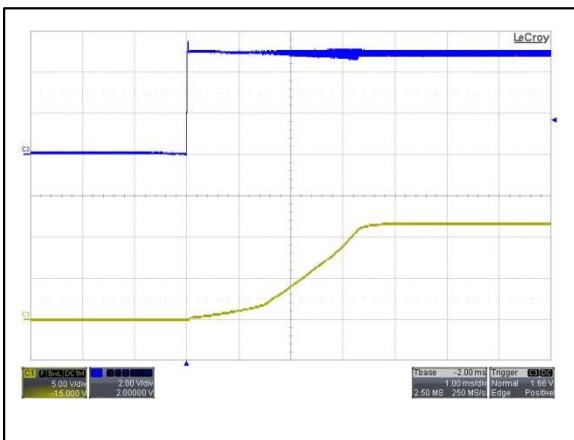

Figure 17: AYA01B05-L Output Voltage Startup Characteristic by Vin
 Vin = 5Vdc Load: Io = 0.25A
 Ch 3: Vin Ch 1: Vo

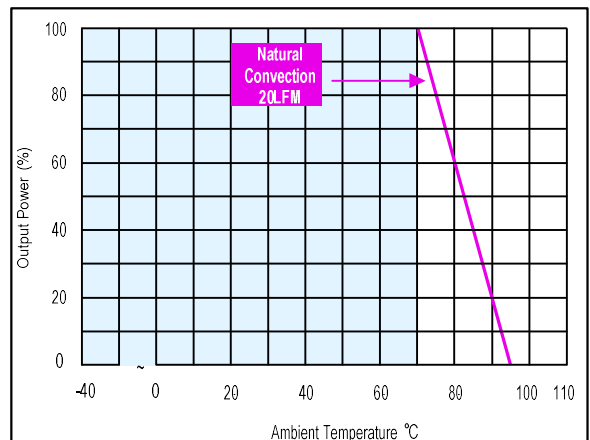

Figure 18: AYA01B05-L Derating Curve
 Vin = 5Vdc

Electrical Specifications

AYA01C05-L Performance Curves

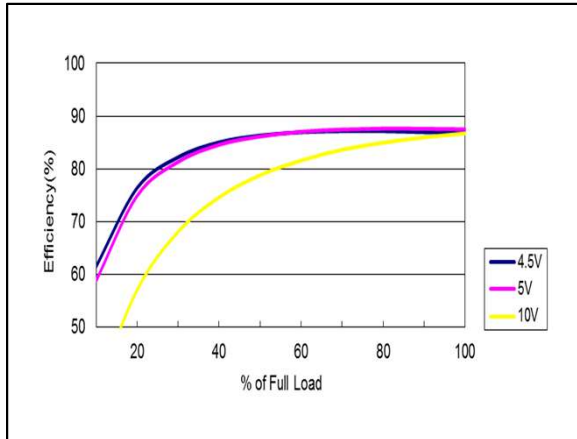

Figure 19: AYA01C05-L Efficiency Versus Output Current Curve
 Vin = 4.5 to 10Vdc Load: Io = 0 to 0.2A

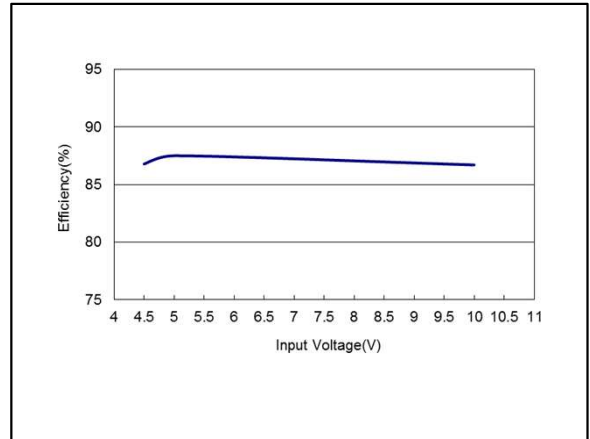

Figure 20: AYA01C05-L Efficiency Versus Input Voltage Curve
 Vin = 4.5 to 10Vdc Load: Io = 0.2A

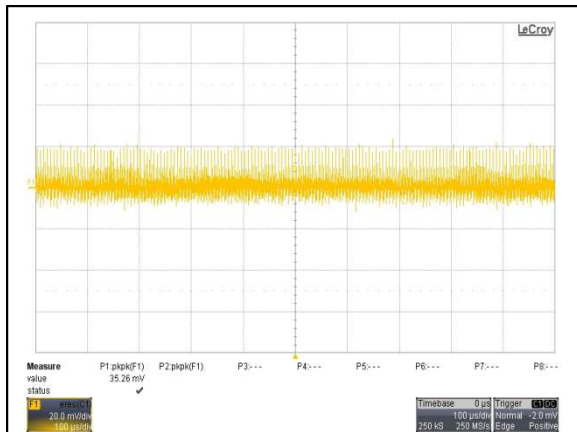

Figure 21: AYA01C05-L Ripple and Noise Measurement
 Vin = 5Vdc Load: Io = 0.2A
 Ch 1: Vo

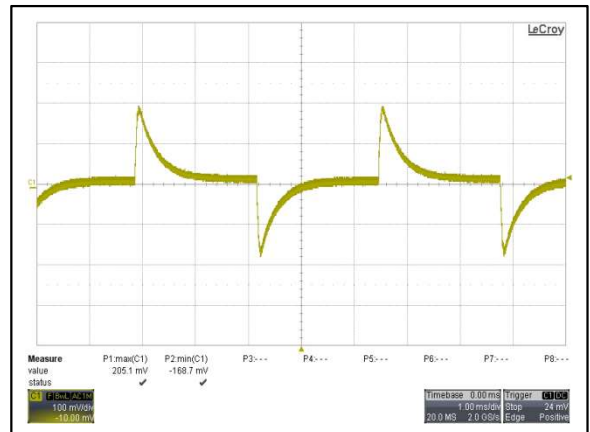

Figure 22: AYA01C05-L Transient Response
 Vin = 5Vdc Load: Io = 100% to 75% load change
 Ch 1: Vo

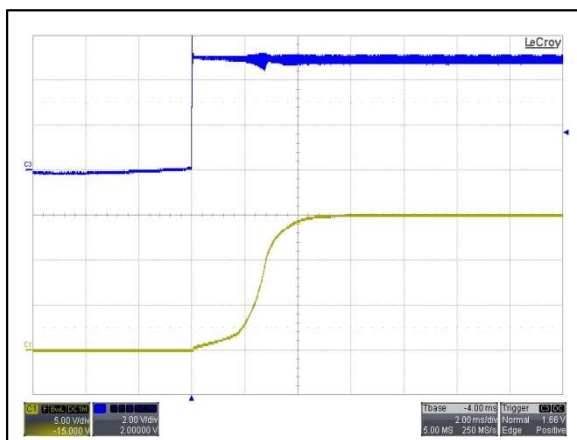

Figure 23: AYA01C05-L Output Voltage Startup Characteristic by Vin
 Vin = 5Vdc Load: Io = 0.2A
 Ch 3: Vin Ch 1: Vo

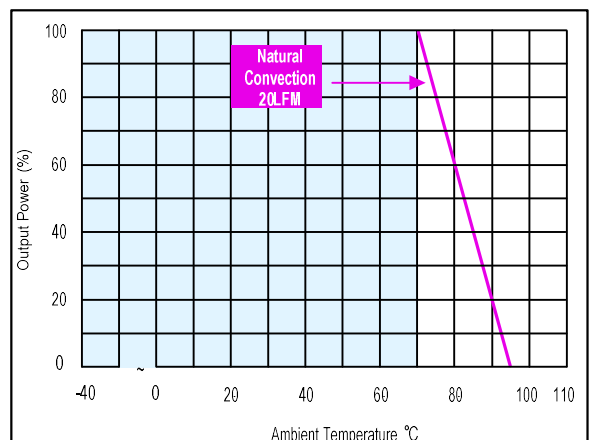

Figure 24: AYA01C05-L Derating Curve
 Vin = 5Vdc

Electrical Specifications

AYA01AA05-L Performance Curves

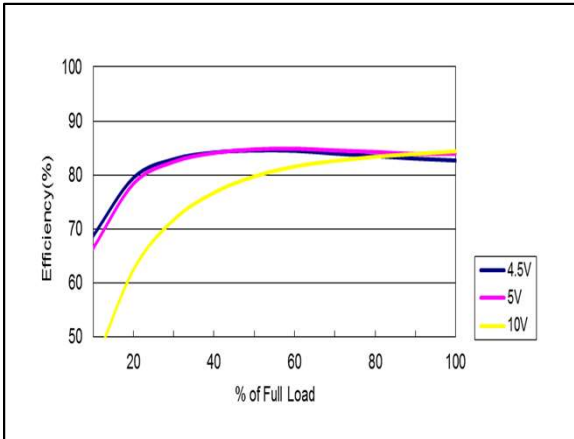

Figure 25: AYA01AA05-L Efficiency Versus Output Current Curve
 Vin = 4.5 to 10Vdc Load: lo = 0 to ±0.3A

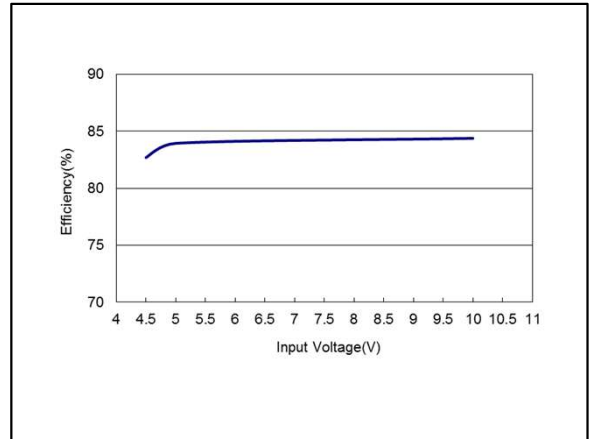

Figure 26: AYA01AA05-L Efficiency Versus Input Voltage Curve
 Vin = 4.5 to 10Vdc Load: lo = ±0.3A

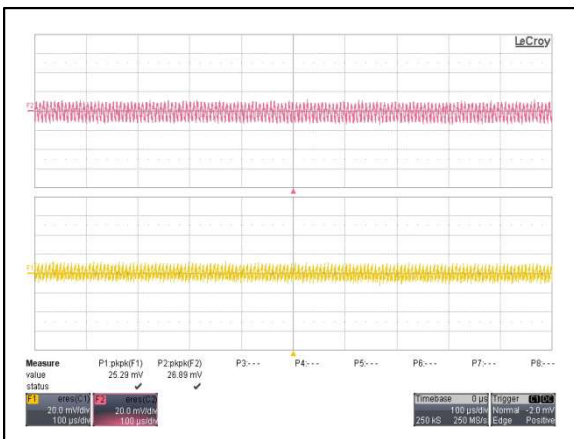

Figure 27: AYA01AA05-L Ripple and Noise Measurement
 Vin = 5Vdc Load: lo = ±0.3A
 Ch 1: Vo1 Ch 2: Vo2

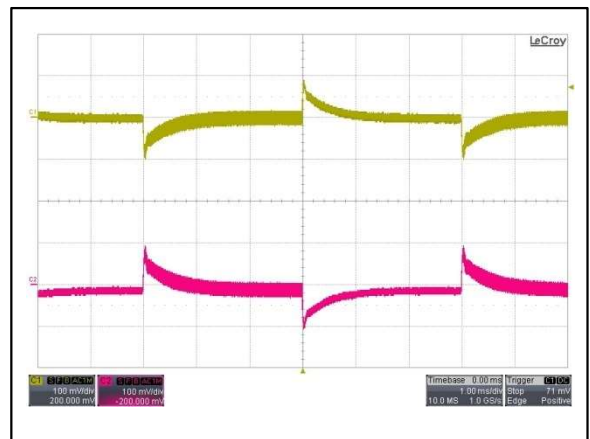

Figure 28: AYA01AA05-L Transient Response
 Vin = 5Vdc Load: lo = 100% to 75% load change
 Ch 1: Vo1 Ch 2: Vo2

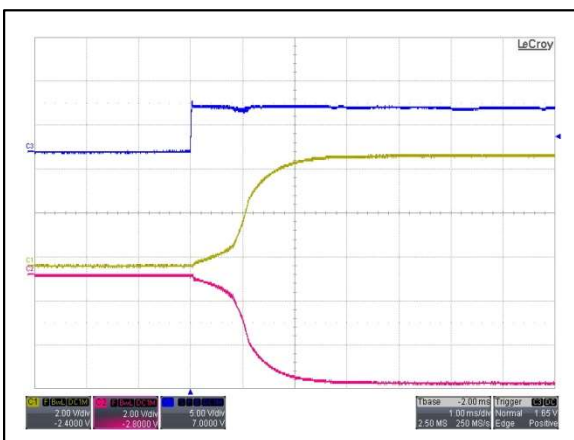

Figure 29: AYA01AA05-L Output Voltage Startup Characteristic by Vin
 Vin = 5Vdc Load: lo = ±0.3A
 Ch 3: Vin Ch 1: Vo1 Ch 2: Vo2

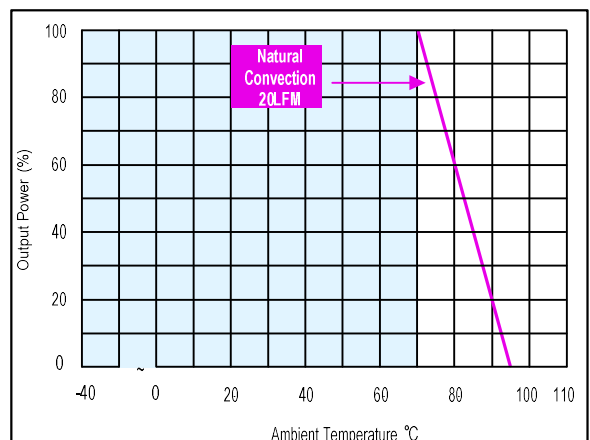

Figure 30: AYA01AA05-L Derating Curve
 Vin = 5Vdc

Electrical Specifications

AYA01BB05-L Performance Curves

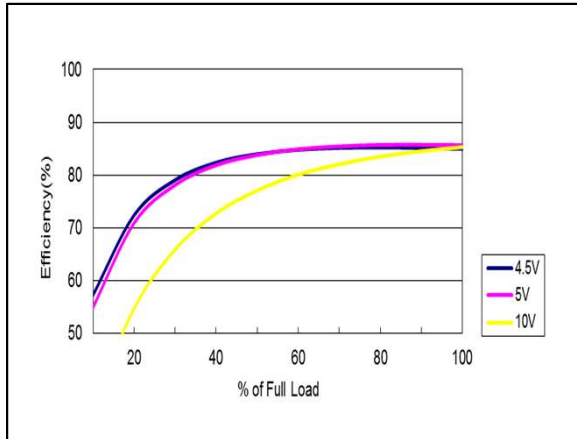

Figure 31: AYA01BB05-L Efficiency Versus Output Current Curve
 Vin = 4.5 to 10Vdc Load: $I_o = 0$ to $\pm 0.125A$

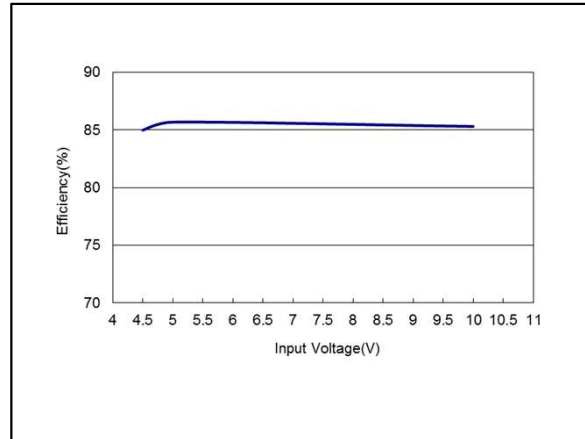

Figure 32: AYA01BB05-L Efficiency Versus Input Voltage Curve
 Vin = 4.5 to 10Vdc Load: $I_o = \pm 0.125A$

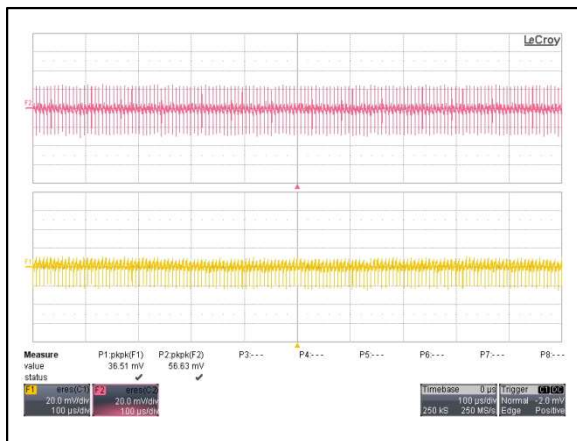

Figure 33: AYA01BB05-L Ripple and Noise Measurement
 Vin = 5Vdc Load: $I_o = \pm 0.125A$
 Ch 1: Vo1 Ch 2: Vo2

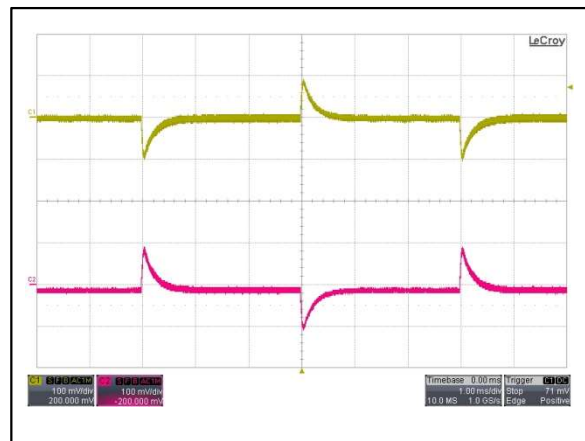

Figure 34: AYA01BB05-L Transient Response
 Vin = 5Vdc Load: $I_o = 100\%$ to 75% load change
 Ch 1: Vo1 Ch 2: Vo2

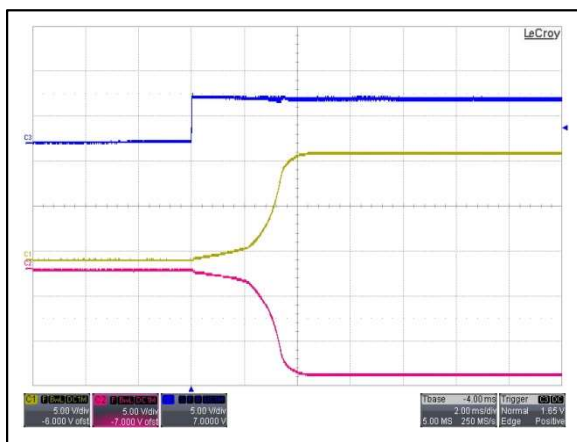

Figure 35: AYA01BB05-L Output Voltage Startup Characteristic by Vin
 Vin = 5Vdc Load: $I_o = \pm 0.125A$
 Ch 3: Vin Ch 1: Vo1 Ch 2: Vo2

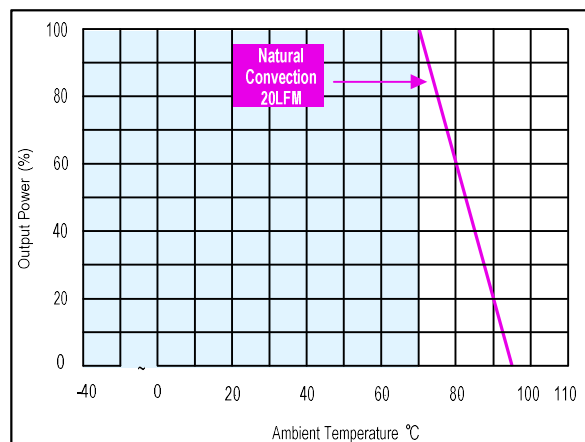

Figure 36: AYA01BB05-L Derating Curve
 Vin = 5Vdc

Electrical Specifications

AYA01CC05-L Performance Curves

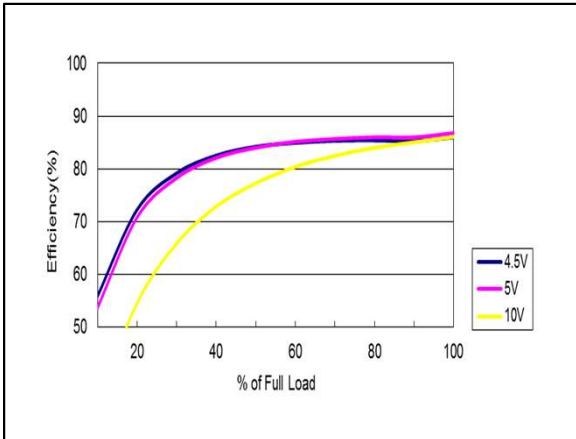

Figure 37: AYA01CC05-L Efficiency Versus Output Current Curve
 Vin = 4.5 to 10Vdc Load: Io = 0 to ±0.1A

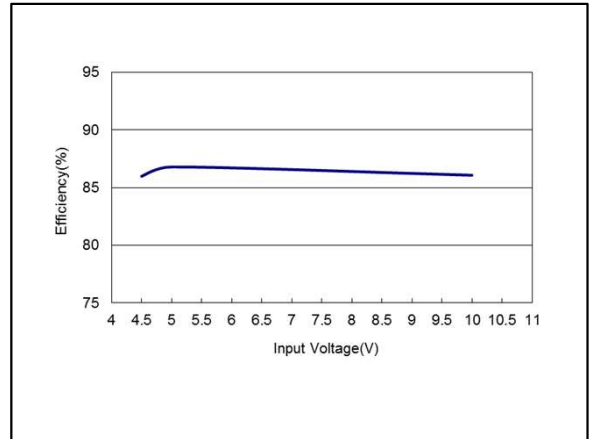

Figure 38: AYA01CC05-L Efficiency Versus Input Voltage Curve
 Vin = 4.5 to 10Vdc Load: Io = ±0.1A

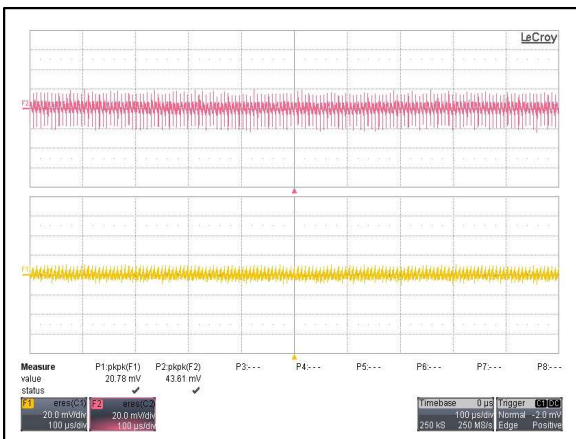

Figure 39: AYA01CC05-L Ripple and Noise Measurement
 Vin = 5Vdc Load: Io = ±0.1A
 Ch 1: Vo1 Ch 2: Vo2

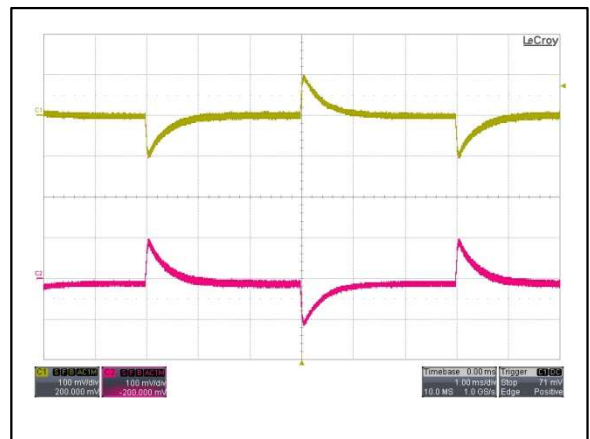

Figure 40: AYA01CC05-L Transient Response
 Vin = 5Vdc Load: Io = 100% to 75% load change
 Ch 1: Vo1 Ch 2: Vo2

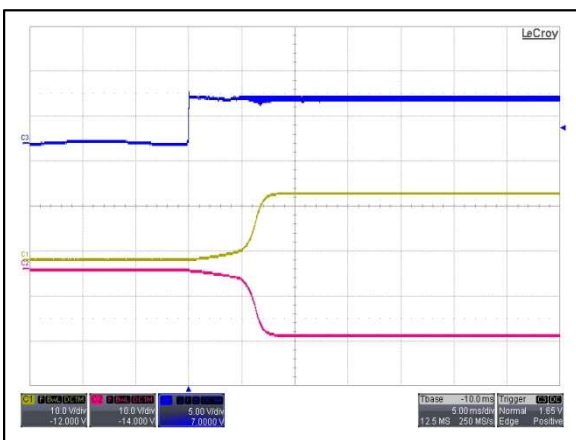

Figure 41: AYA01CC05-L Output Voltage Startup Characteristic by Vin
 Vin = 5Vdc Load: Io = ±0.1A
 Ch 3: Vin Ch 1: Vo1 Ch 2: Vo2

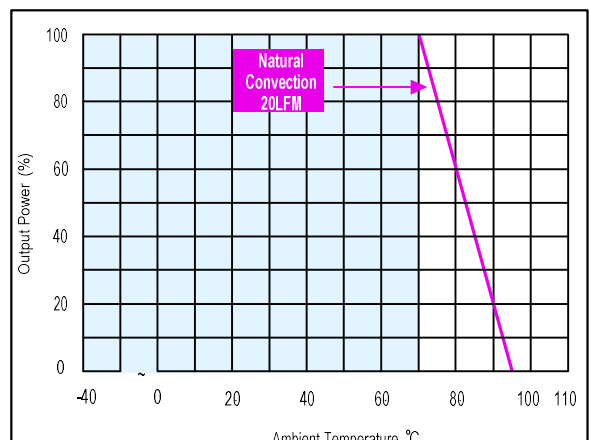

Figure 42: AYA01CC05-L Derating Curve
 Vin = 5Vdc

Electrical Specifications

AYA01F12-L Performance Curves

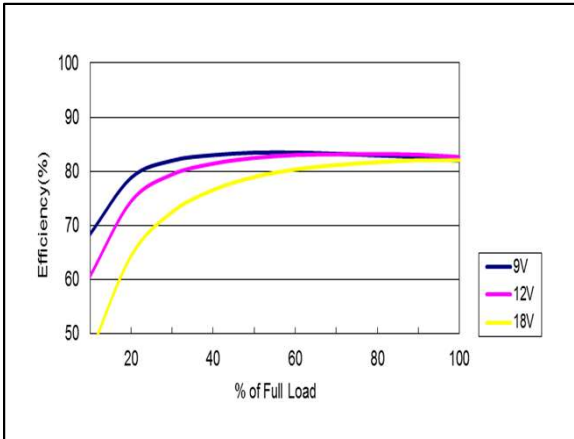

Figure 43: AYA01F12-L Efficiency Versus Output Current Curve
 Vin = 9 to 18Vdc Load: Io = 0 to 0.6A

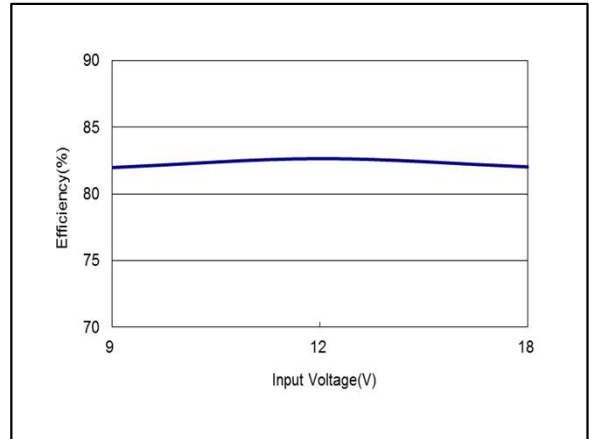

Figure 44: AYA01F12-L Efficiency Versus Input Voltage Curve
 Vin = 9 to 18Vdc Load: Io = 0.6A

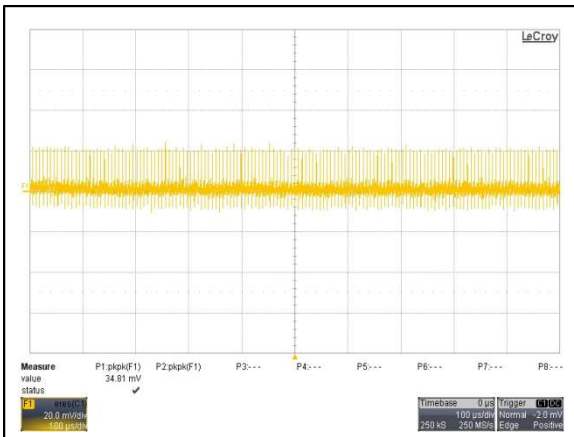

Figure 45: AYA01F12-L Ripple and Noise Measurement
 Vin = 12Vdc Load: Io = 0.6A
 Ch 1: Vo

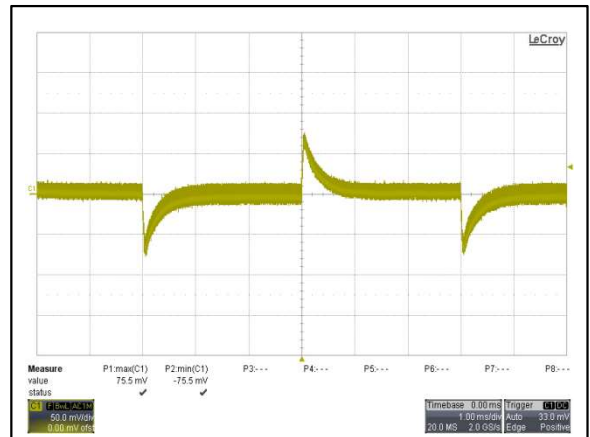

Figure 46: AYA01F12-L Transient Response
 Vin = 12Vdc Load: Io = 100% to 75% load change
 Ch 1: Vo

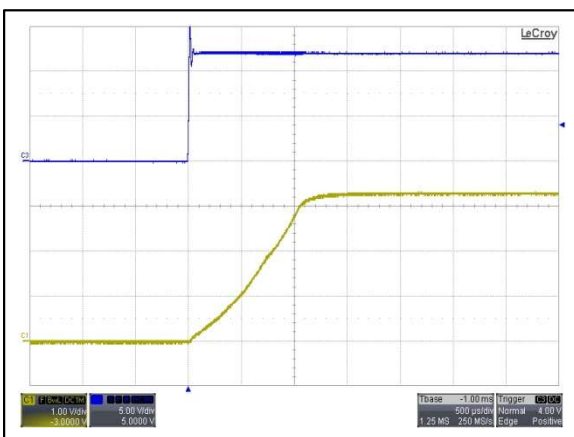

Figure 47: AYA01F12-L Output Voltage Startup Characteristic by Vin
 Vin = 12Vdc Load: Io = 0.6A
 Ch 3: Vin Ch 1: Vo

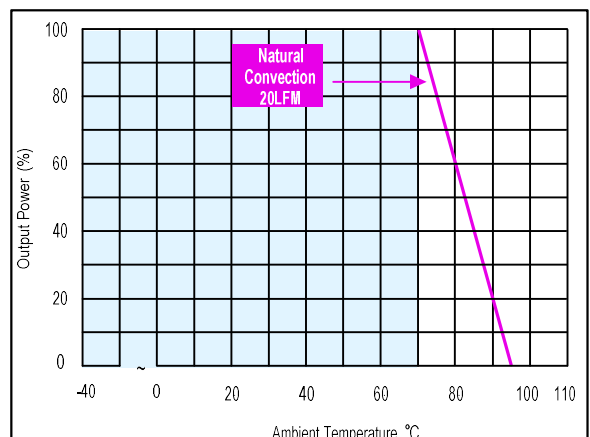

Figure 48: AYA01F12-L Derating Curve
 Vin = 12Vdc

Electrical Specifications

AYA01A12-L Performance Curves

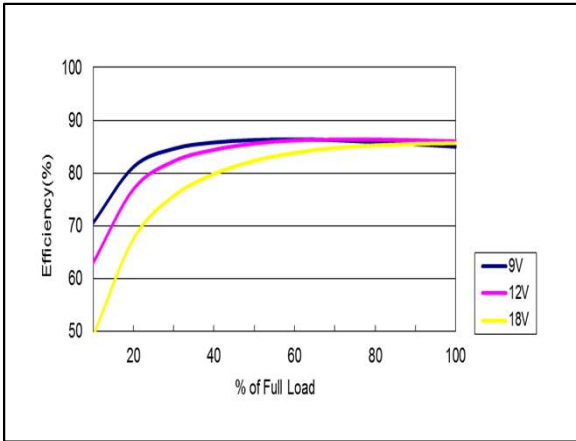

Figure 49: AYA01A12-L Efficiency Versus Output Current Curve
 Vin = 9 to 18Vdc Load: Io = 0 to 0.6A

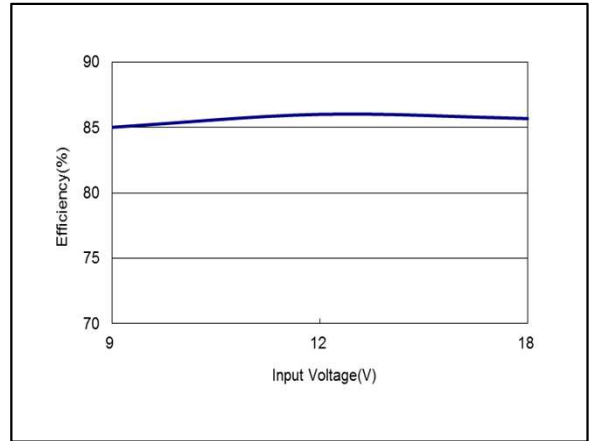

Figure 50: AYA01A12-L Efficiency Versus Input Voltage Curve
 Vin = 9 to 18Vdc Load: Io = 0.6A

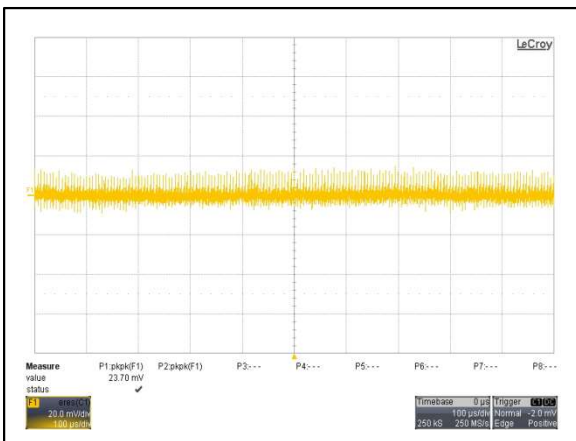

Figure 51: AYA01A12-L Ripple and Noise Measurement
 Vin = 12Vdc Load: Io = 0.6A
 Ch 1: Vo

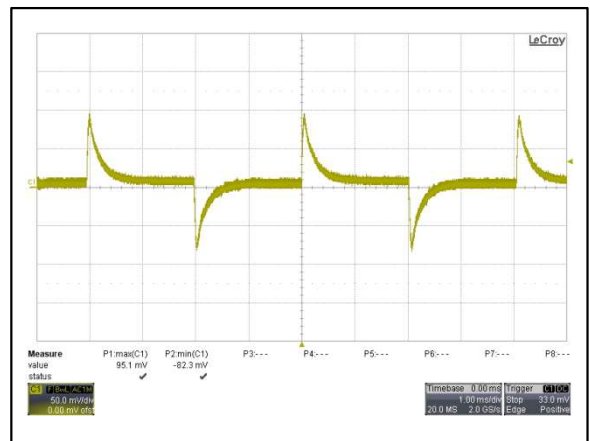

Figure 52: AYA01A12-L Transient Response
 Vin = 12Vdc Load: Io = 100% to 75% load change
 Ch 1: Vo

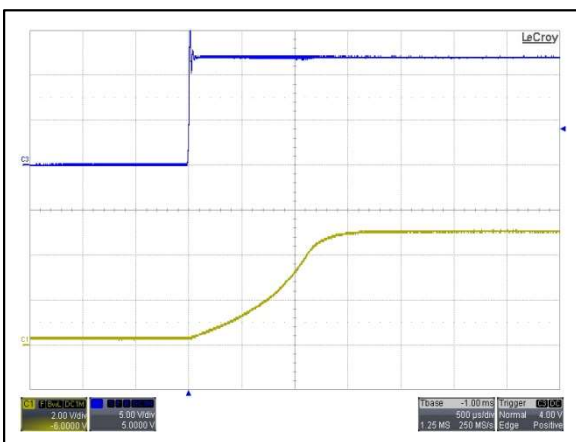

Figure 53: AYA01A12-L Output Voltage Startup Characteristic by Vin
 Vin = 12Vdc Load: Io = 0.6A
 Ch 3: Vin Ch 1: Vo

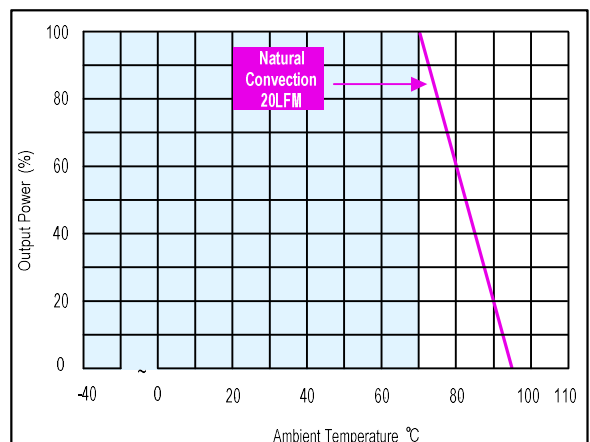

Figure 54: AYA01A12-L Derating Curve
 Vin = 12Vdc

Electrical Specifications

AYA01B12-L Performance Curves

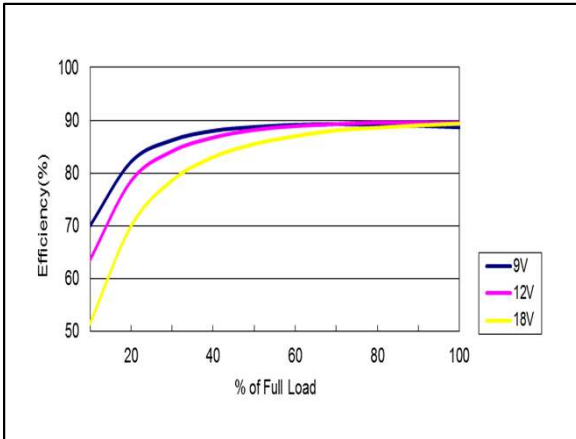

Figure 55: AYA01B12-L Efficiency Versus Output Current Curve
 Vin = 9 to 18Vdc Load: Io = 0 to 0.25A

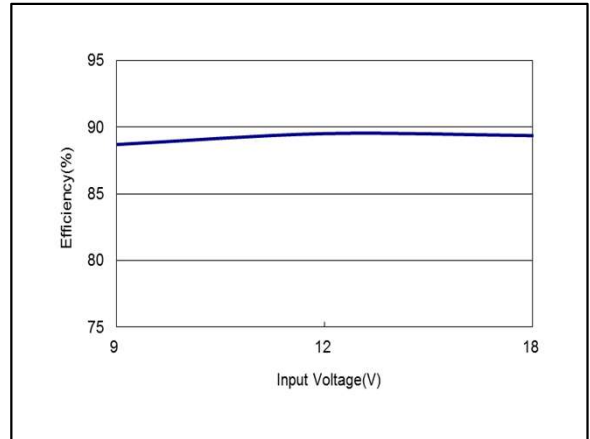

Figure 56: AYA01B12-L Efficiency Versus Input Voltage Curve
 Vin = 9 to 18Vdc Load: Io = 0.25A

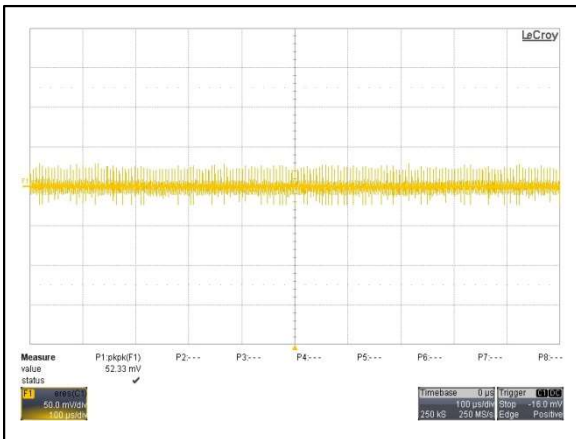

Figure 57: AYA01B12-L Ripple and Noise Measurement
 Vin = 12Vdc Load: Io = 0.25A
 Ch 1: Vo

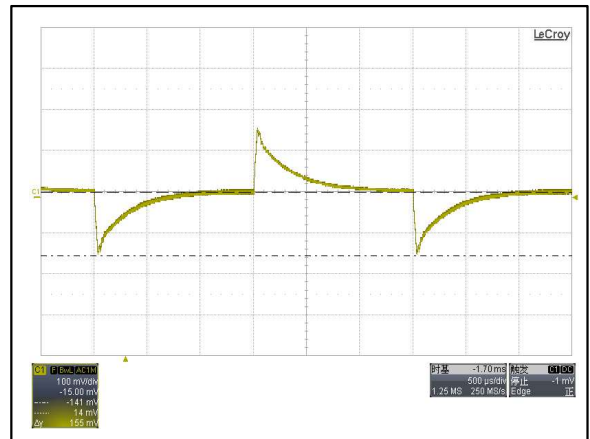

Figure 58: AYA01B12-L Transient Response
 Vin = 12Vdc Load: Io = 100% to 75% load change
 Ch 1: Vo

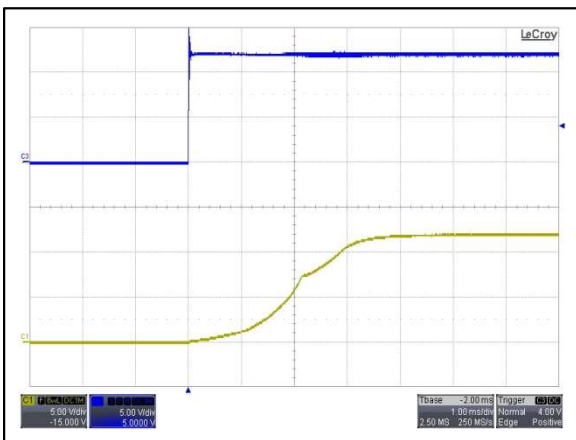

Figure 59: AYA01B12-L Output Voltage Startup Characteristic by Vin
 Vin = 12Vdc Load: Io = 0.25A
 Ch 3: Vin Ch 1: Vo

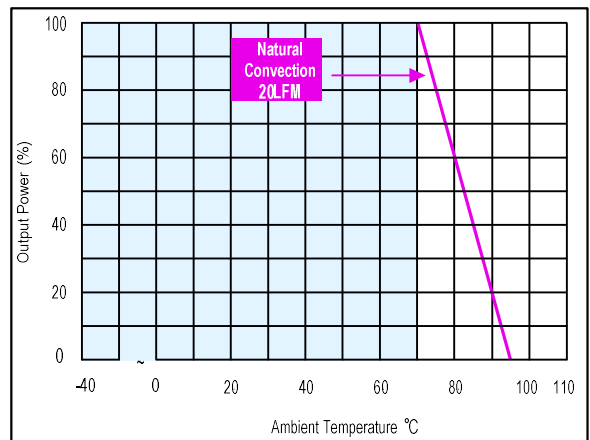

Figure 60: AYA01B12-L Derating Curve
 Vin = 12Vdc

Electrical Specifications

AYA01C12-L Performance Curves

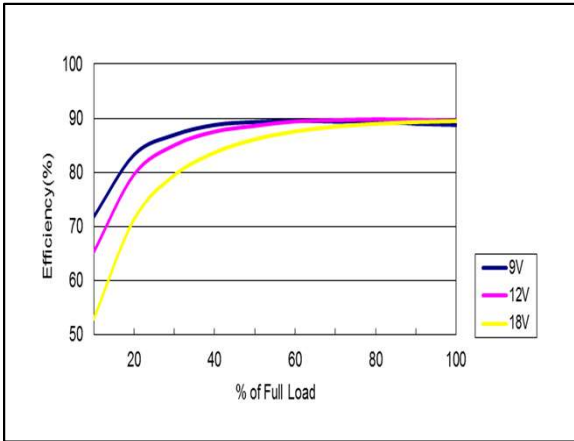

Figure 61: AYA01C12-L Efficiency Versus Output Current Curve
 Vin = 9 to 18Vdc Load: Io = 0 to 0.2A

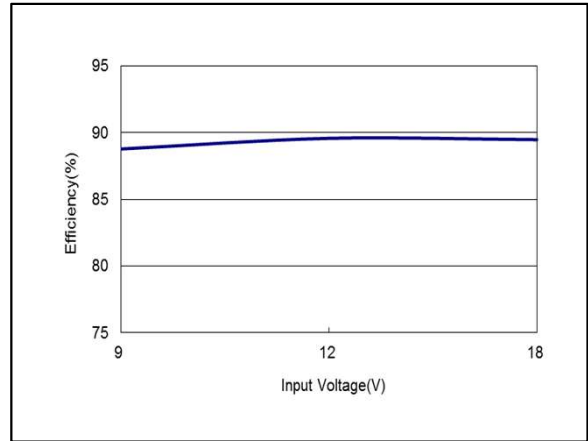

Figure 62: AYA01C12-L Efficiency Versus Input Voltage Curve
 Vin = 9 to 18Vdc Load: Io = 0.2A

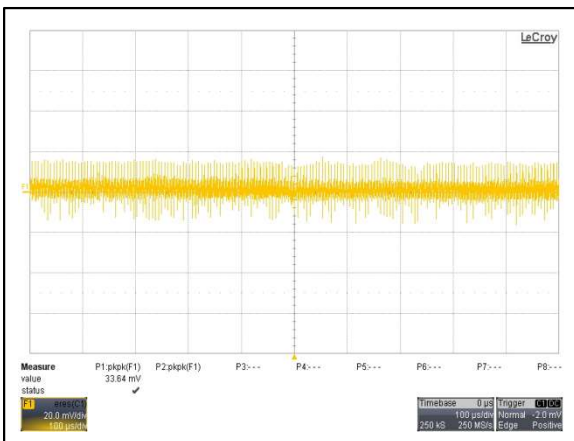

Figure 63: AYA01C12-L Ripple and Noise Measurement
 Vin = 12Vdc Load: Io = 0.2A
 Ch 1: Vo

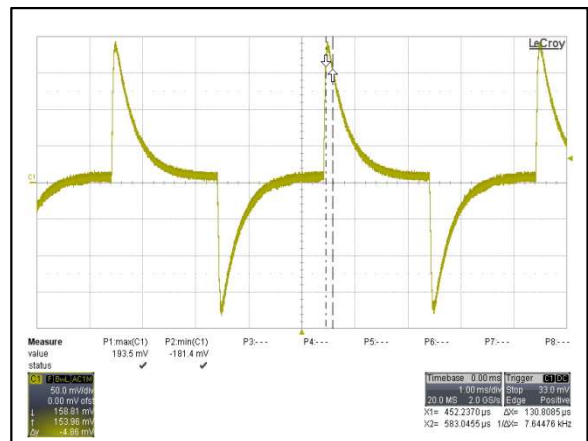

Figure 64: AYA01C12-L Transient Response
 Vin = 12Vdc Load: Io = 100% to 75% load change
 Ch 1: Vo

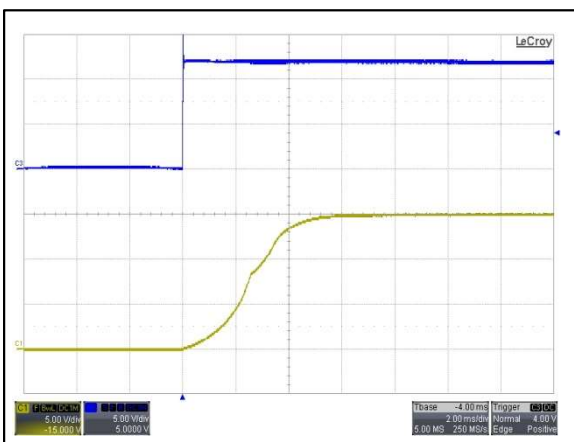

Figure 65: AYA01C12-L Output Voltage Startup Characteristic by Vin
 Vin = 12Vdc Load: Io = 0.2A
 Ch 3: Vin Ch 1: Vo

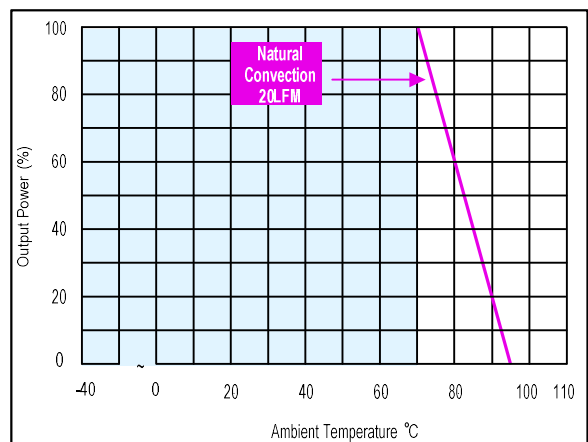

Figure 66: AYA01C12-L Derating Curve
 Vin = 12Vdc

Electrical Specifications

AYA01AA12-L Performance Curves

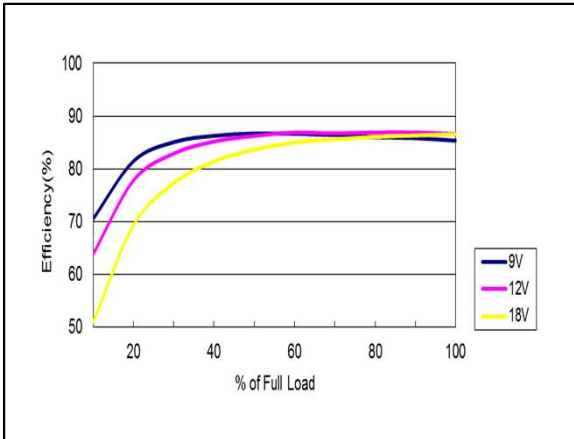

Figure 67: AYA01AA12-L Efficiency Versus Output Current Curve
 Vin = 9 to 18Vdc Load: Io = 0 to ±0.3A

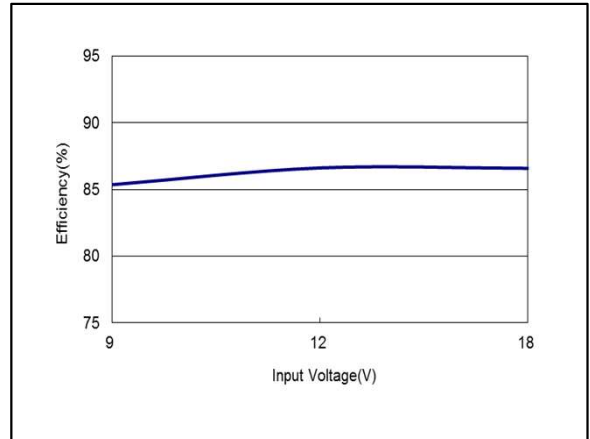

Figure 68: AYA01AA12-L Efficiency Versus Input Voltage Curve
 Vin = 9 to 18Vdc Load: Io = ±0.3A

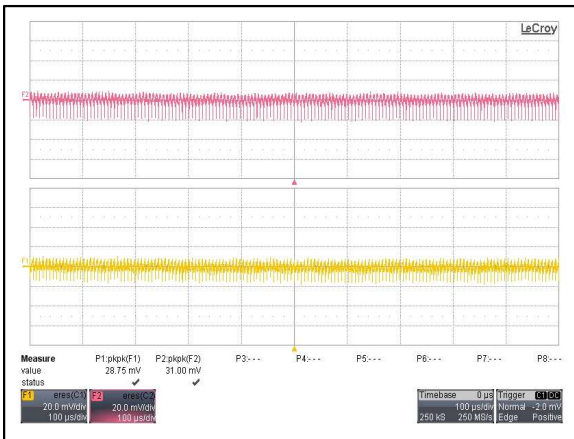

Figure 69: AYA01AA12-L Ripple and Noise Measurement
 Vin = 12Vdc Load: Io = ±0.3A
 Ch 1: Vo

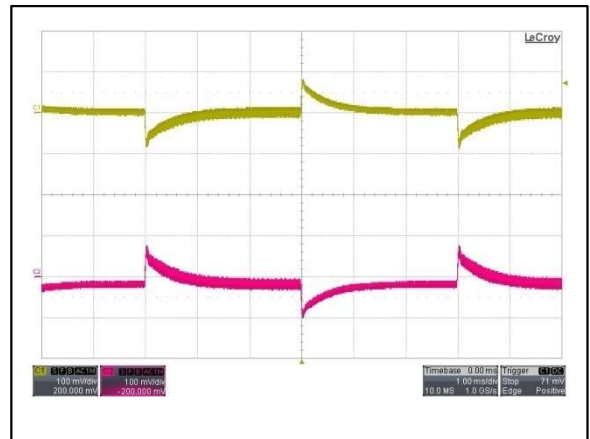

Figure 70: AYA01AA12-L Transient Response
 Vin = 12Vdc Load: Io = 100% to 75% load change
 Ch 1: Vo1 Ch 2: Vo2

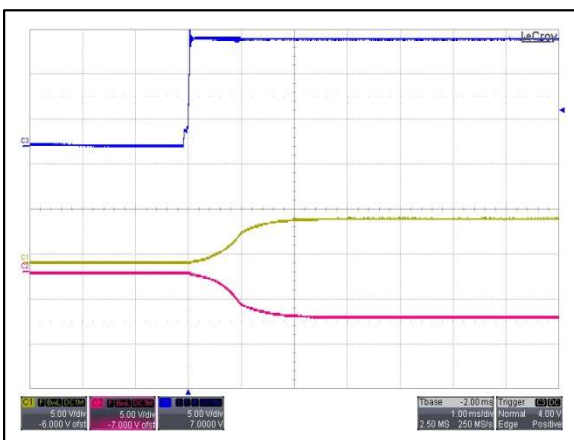

Figure 71: AYA01AA12-L Output Voltage Startup Characteristic by Vin
 Vin = 12Vdc Load: Io = ±0.3A
 Ch 3: Vin Ch 1: Vo1 Ch 2: Vo2

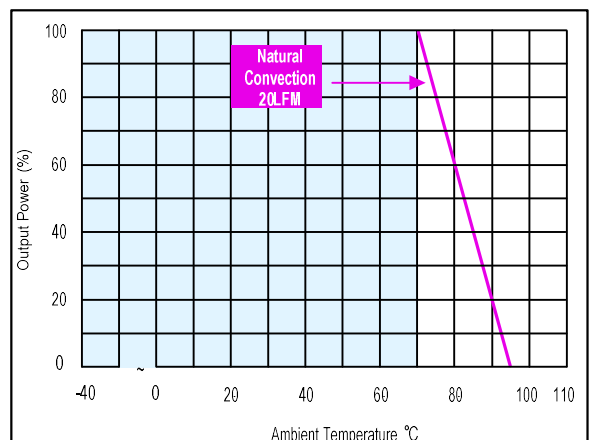

Figure 72: AYA01AA12-L Derating Curve
 Vin = 12Vdc

Electrical Specifications

AYA01BB12-L Performance Curves

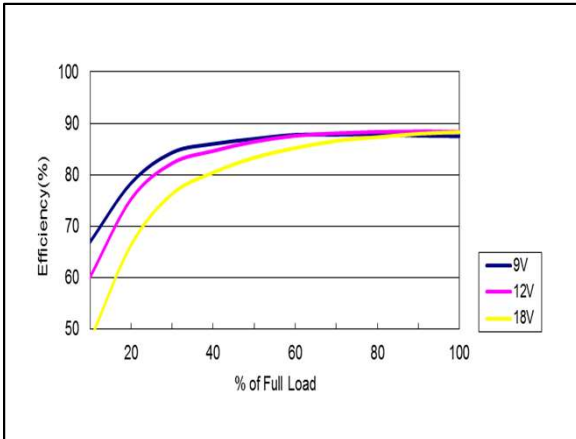

Figure 73: AYA01BB12-L Efficiency Versus Output Current Curve
 Vin = 9 to 18Vdc Load: Io = 0 to ±0.1A

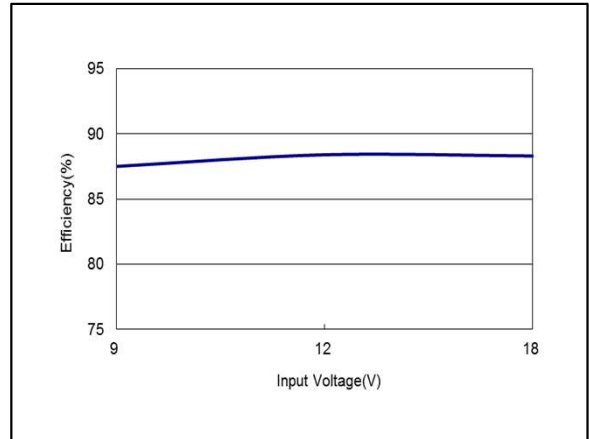

Figure 74: AYA01BB12-L Efficiency Versus Input Voltage Curve
 Vin = 9 to 18Vdc Load: Io = ±0.1A

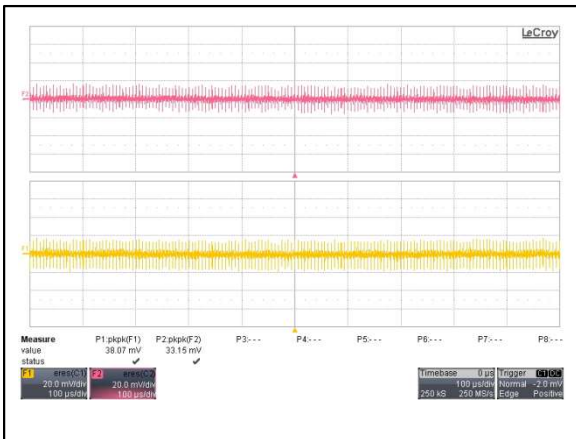

Figure 75: AYA01BB12-L Ripple and Noise Measurement
 Vin = 12Vdc Load: Io = ±0.1A
 Ch 1: Vo1 Ch 2: Vo2

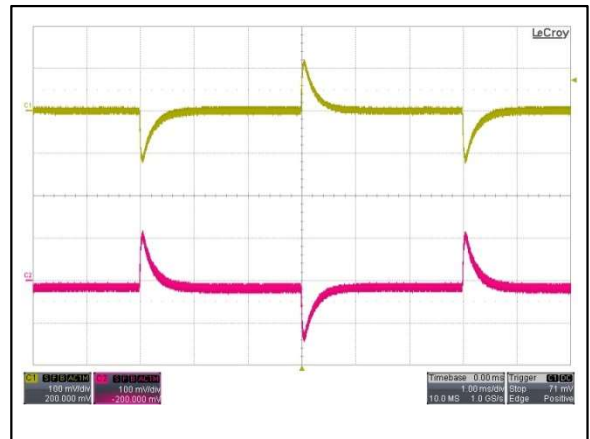

Figure 76: AYA01BB12-L Transient Response
 Vin = 12Vdc Load: Io = 100% to 75% load change
 Ch 1: Vo1 Ch 2: Vo2

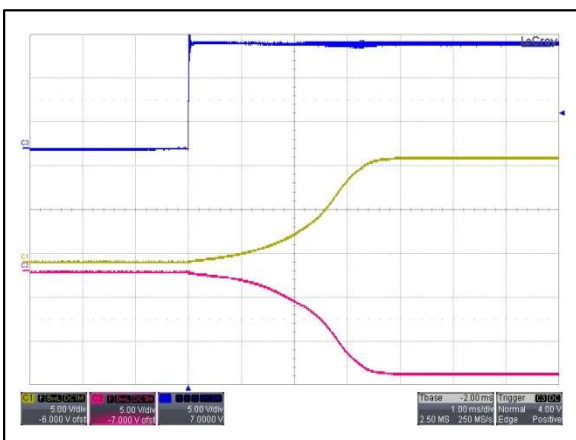

Figure 77: AYA01BB12-L Output Voltage Startup Characteristic by Vin
 Vin = 12Vdc Load: Io = ±0.1A
 Ch 3: Vin Ch 1: Vo1 Ch 2: Vo2

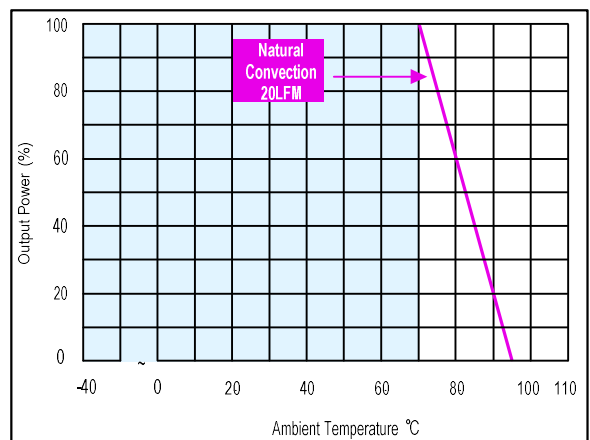

Figure 78: AYA01BB12-L Derating Curve
 Vin = 12Vdc

Electrical Specifications

AYA01CC12-L Performance Curves

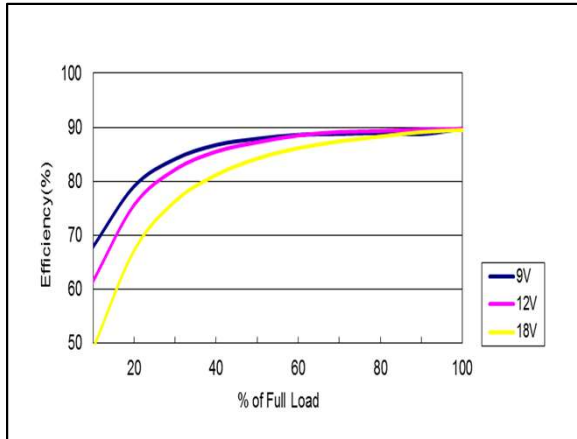

Figure 79: AYA01CC12-L Efficiency Versus Output Current Curve
 Vin = 9 to 18Vdc Load: Io = 0 to ±0.1A

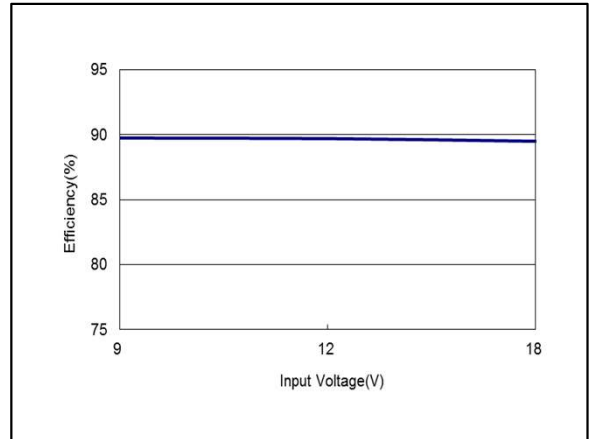

Figure 80: AYA01CC12-L Efficiency Versus Input Voltage Curve
 Vin = 9 to 18Vdc Load: Io = ±0.1A

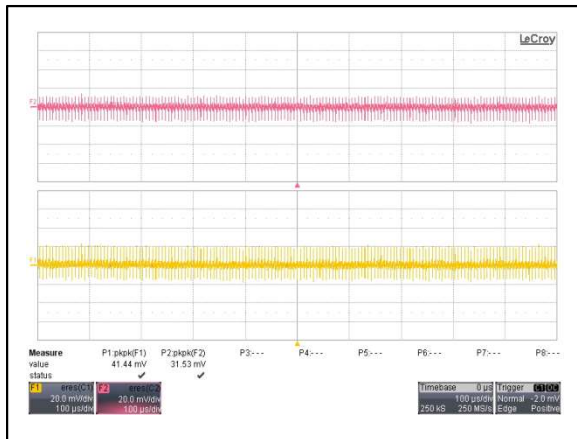

Figure 81: AYA01CC12-L Ripple and Noise Measurement
 Vin = 12Vdc Load: Io = ±0.1A
 Ch 1: Vo1 Ch 2: Vo2

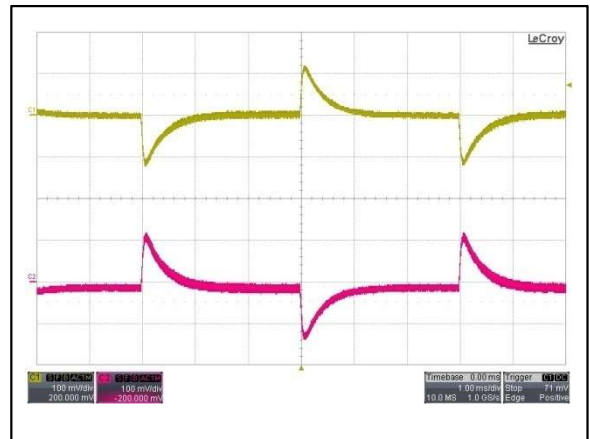

Figure 82: AYA01CC12-L Transient Response
 Vin = 12Vdc Load: Io = 100% to 75% load change
 Ch 1: Vo1 Ch 2: Vo2

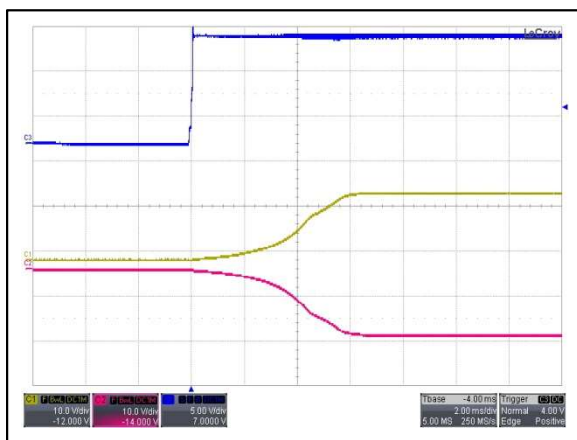

Figure 83: AYA01CC12-L Output Voltage Startup Characteristic by Vin
 Vin = 12Vdc Load: Io = ±0.1A
 Ch 3: Vin Ch 1: Vo1 Ch 2: Vo2

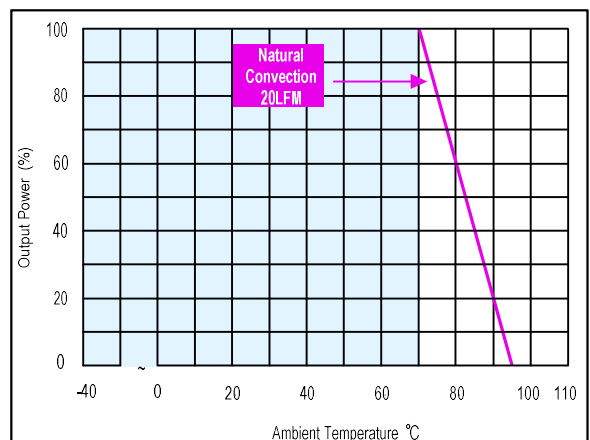

Figure 84: AYA01CC12-L Derating Curve
 Vin = 12Vdc

Electrical Specifications

AYA01F24-L Performance Curves

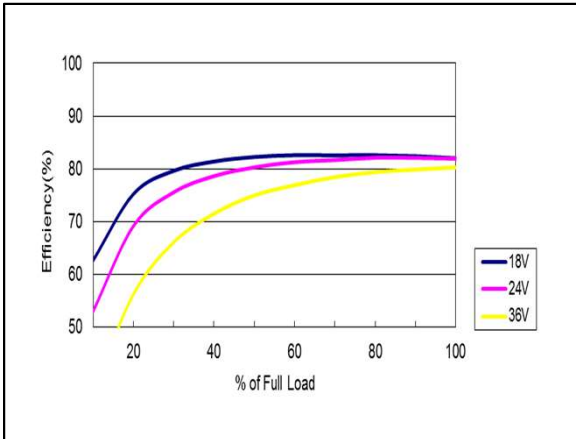

Figure 85: AYA01F24-L Efficiency Versus Output Current Curve
 Vin = 18 to 36Vdc Load: Io = 0 to 0.6A

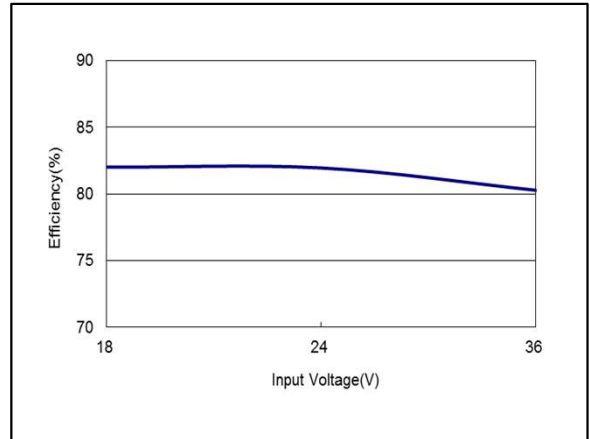

Figure 86: AYA01F24-L Efficiency Versus Input Voltage Curve
 Vin = 18 to 36Vdc Load: Io = 0.6A

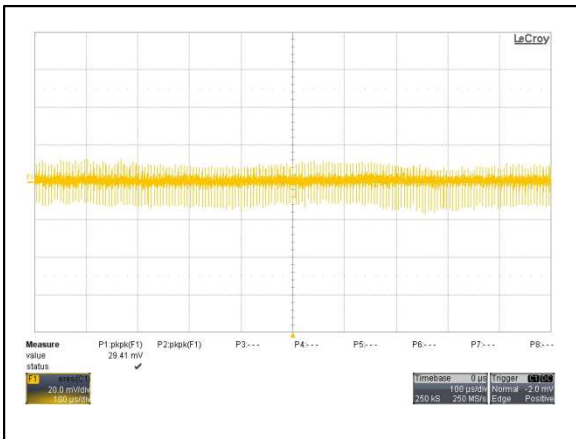

Figure 87: AYA01F24-L Ripple and Noise Measurement
 Vin = 24Vdc Load: Io = 0.6A
 Ch 1: Vo

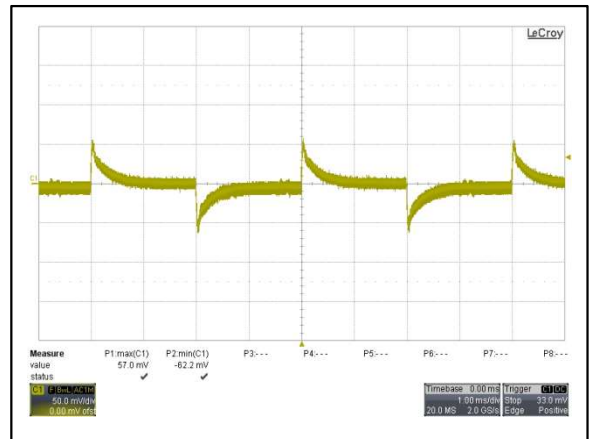

Figure 88: AYA01F24-L Transient Response
 Vin = 24Vdc Load: Io = 100% to 75% load change
 Ch 1: Vo

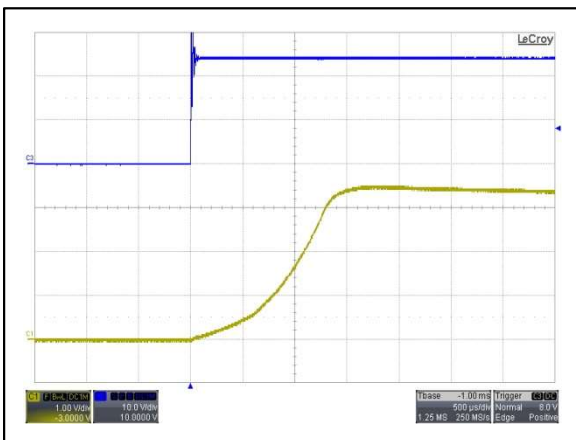

Figure 89: AYA01F24-L Output Voltage Startup Characteristic by Vin
 Vin = 24Vdc Load: Io = 0.6A
 Ch 3: Vin Ch 1: Vo

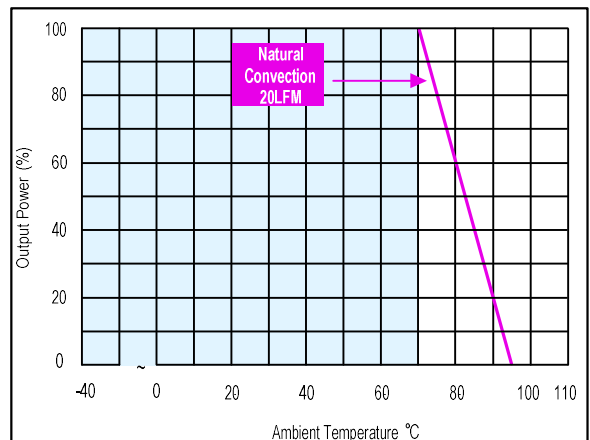

Figure 90: AYA01F24-L Derating Curve
 Vin = 24Vdc

Electrical Specifications

AYA01A24-L Performance Curves

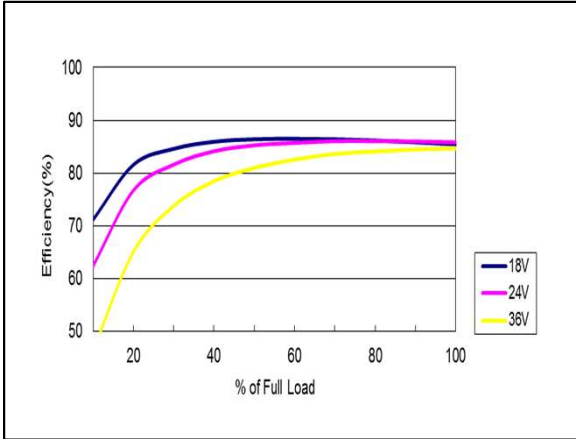

Figure 91: AYA01A24-L Efficiency Versus Output Current Curve
 Vin = 18 to 36Vdc Load: Io = 0 to 0.6A

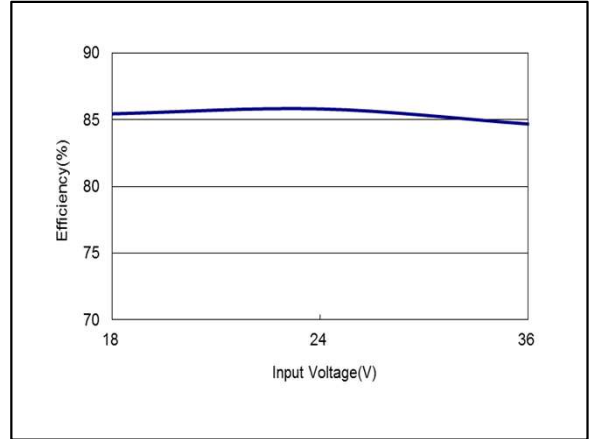

Figure 92: AYA01A24-L Efficiency Versus Input Voltage Curve
 Vin = 18 to 36Vdc Load: Io = 0.6A

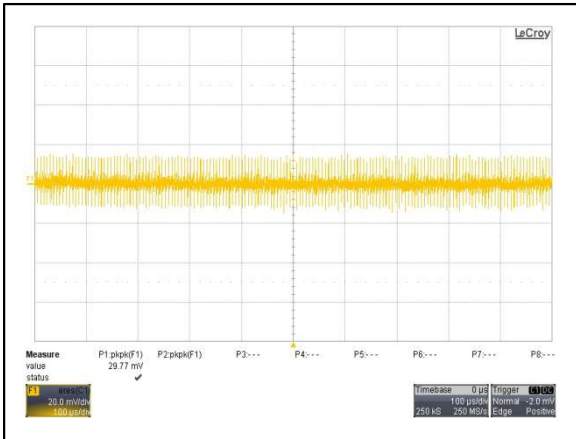

Figure 93: AYA01A24-L Ripple and Noise Measurement
 Vin = 24Vdc Load: Io = 0.6A
 Ch 1: Vo

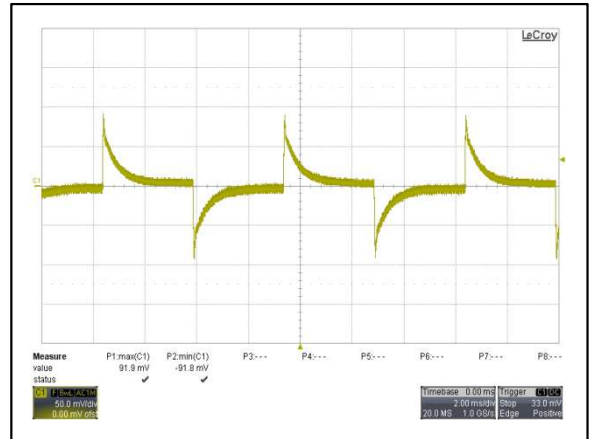

Figure 94: AYA01A24-L Transient Response
 Vin = 24Vdc Load: Io = 100% to 75% load change
 Ch 1: Vo

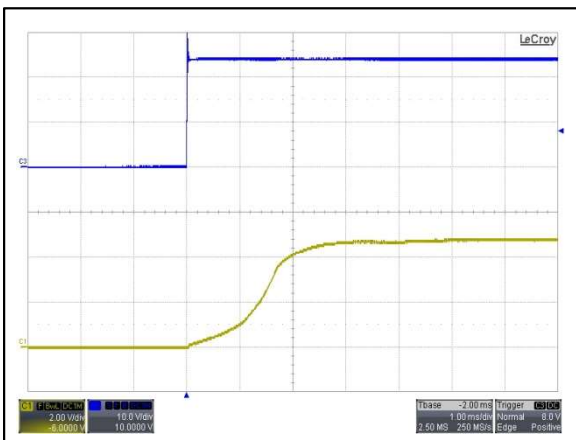

Figure 95: AYA01A24-L Output Voltage Startup Characteristic by Vin
 Vin = 24Vdc Load: Io = 0.6A
 Ch 3: Vin Ch 1: Vo

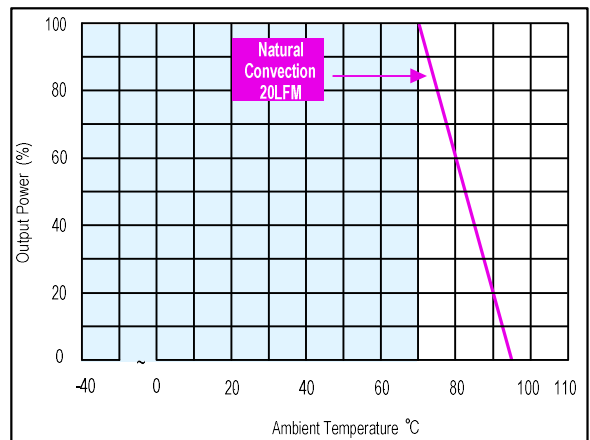

Figure 96: AYA01A24-L Derating Curve
 Vin = 24Vdc

Electrical Specifications

AYA01B24-L Performance Curves

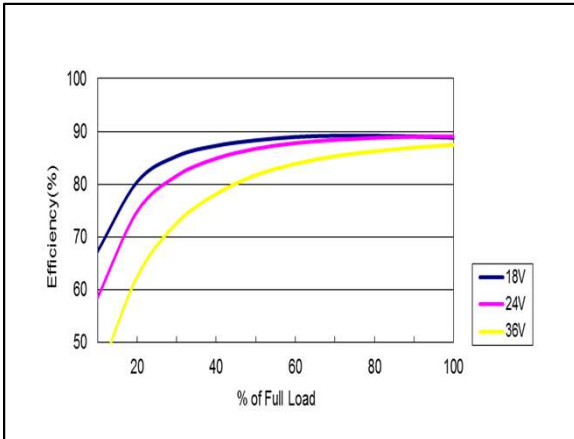

Figure 97: AYA01B24-L Efficiency Versus Output Current Curve
 Vin = 18 to 36Vdc Load: Io = 0 to 0.25A

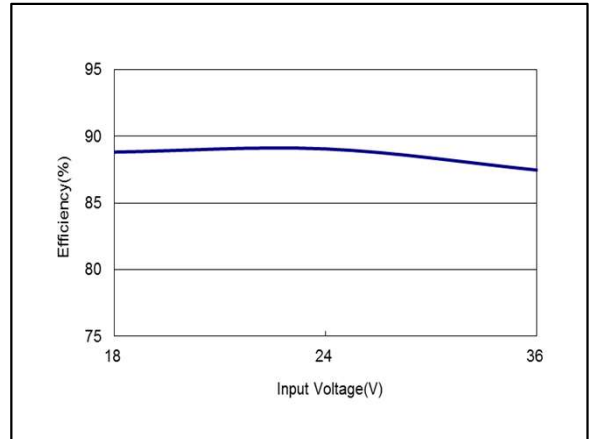

Figure 98: AYA01B24-L Efficiency Versus Input Voltage Curve
 Vin = 18 to 36Vdc Load: Io = 0.25A

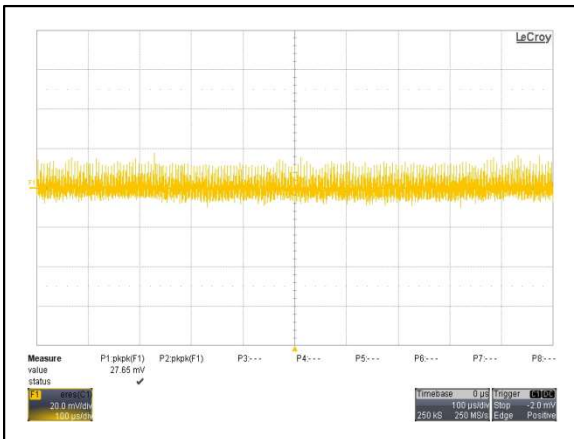

Figure 99: AYA01B24-L Ripple and Noise Measurement
 Vin = 24Vdc Load: Io = 0.25A
 Ch 1: Vo

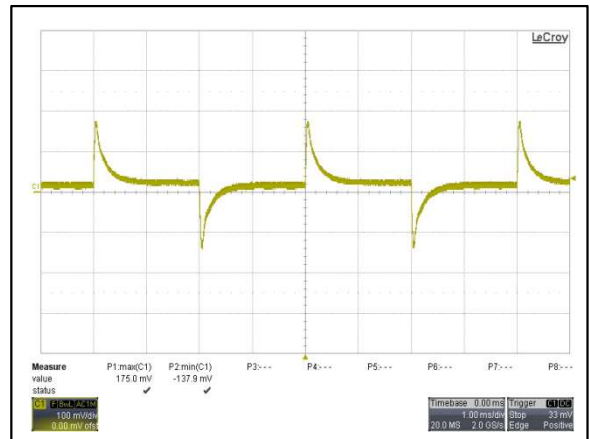

Figure 100: AYA01B24-L Transient Response
 Vin = 24Vdc Load: Io = 100% to 75% load change
 Ch 1: Vo

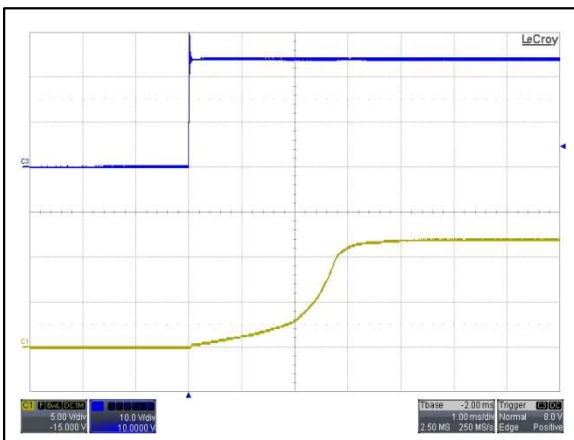

Figure 101: AYA01B24-L Output Voltage Startup Characteristic by Vin
 Vin = 24Vdc Load: Io = 0.25A
 Ch 3: Vin Ch 1: Vo

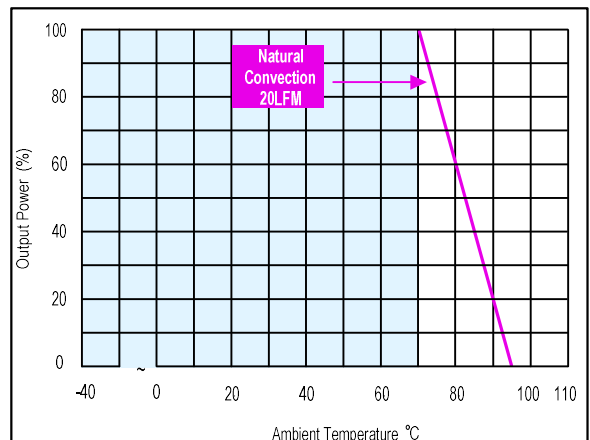

Figure 102: AYA01B24-L Derating Curve
 Vin = 24Vdc

Electrical Specifications

AYA01C24-L Performance Curves

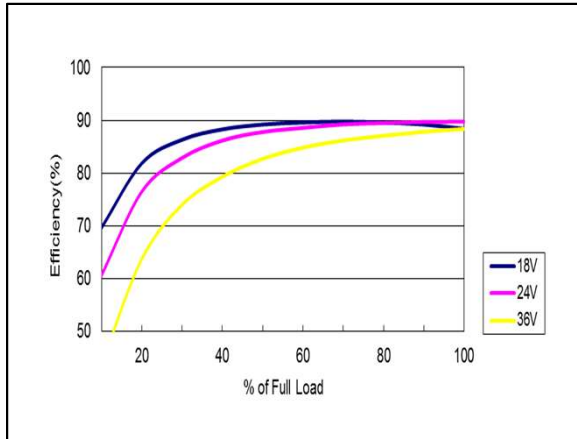

Figure 103: AYA01C24-L Efficiency Versus Output Current Curve
 Vin = 18 to 36Vdc Load: Io = 0 to 0.2A

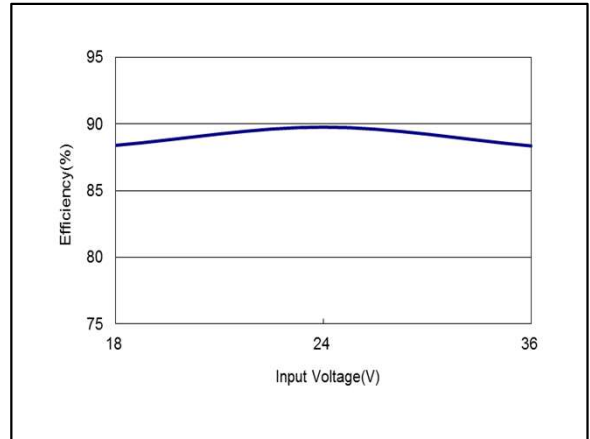

Figure 104: AYA01C24-L Efficiency Versus Input Voltage Curve
 Vin = 18 to 36Vdc Load: Io = 0.2A

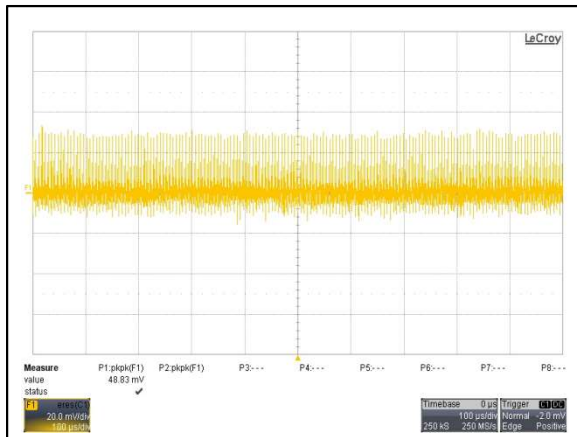

Figure 105: AYA01C24-L Ripple and Noise Measurement
 Vin = 24Vdc Load: Io = 0.2A
 Ch 1: Vo

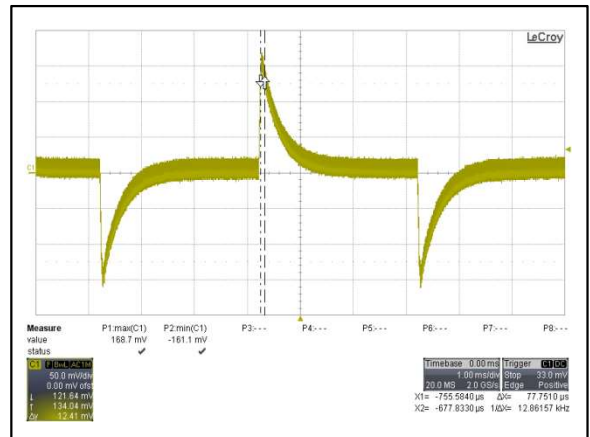

Figure 106: AYA01C24-L Transient Response
 Vin = 24Vdc Load: Io = 100% to 75% load change
 Ch 1: Vo

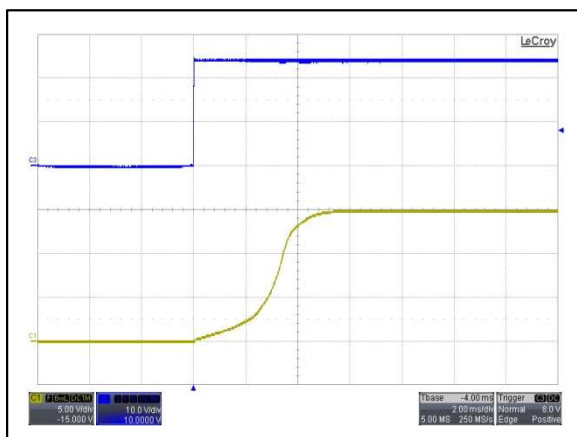

Figure 107: AYA01C24-L Output Voltage Startup Characteristic by Vin
 Vin = 24Vdc Load: Io = 0.2A
 Ch 3: Vin Ch 1: Vo

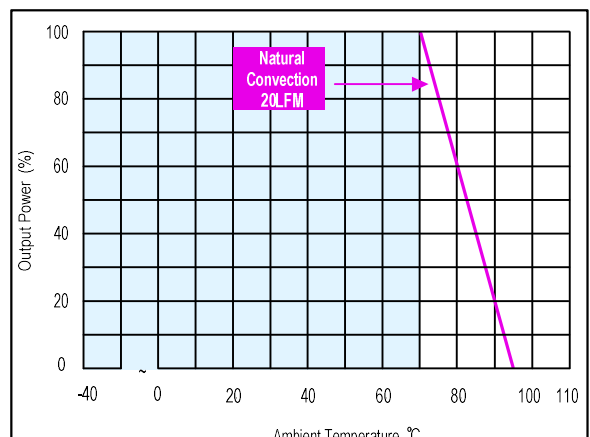

Figure 108: AYA01C24-L Derating Curve
 Vin = 24Vdc

Electrical Specifications

AYA01AA24-L Performance Curves

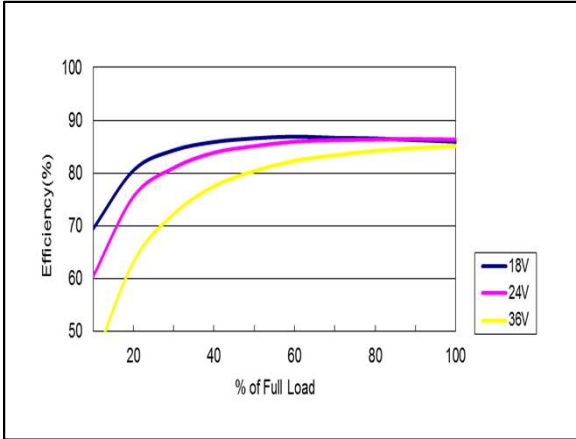

Figure 109: AYA01AA24-L Efficiency Versus Output Current Curve
 Vin = 18 to 36Vdc Load: Io = 0 to ±0.3A

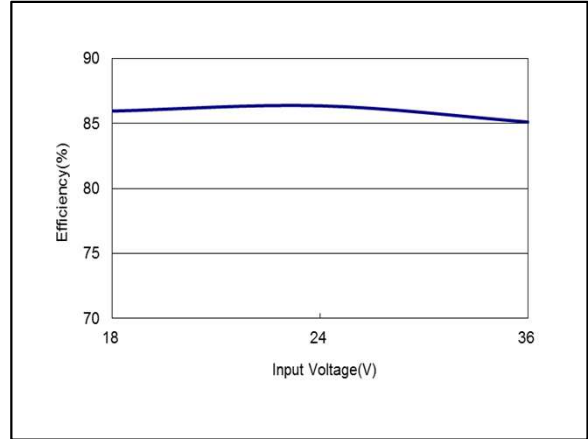

Figure 110: AYA01AA24-L Efficiency Versus Input Voltage Curve
 Vin = 18 to 36Vdc Load: Io = ±0.3A

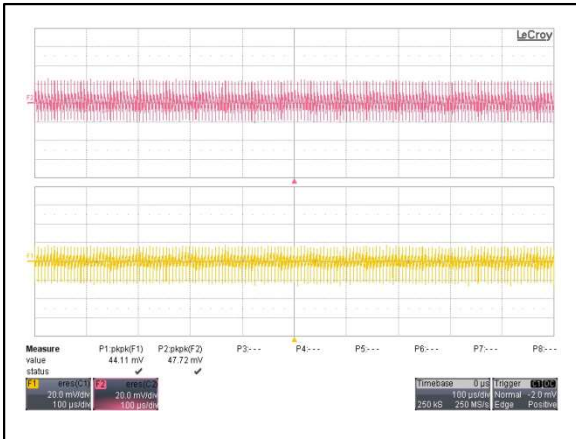

Figure 111: AYA01AA24-L Ripple and Noise Measurement
 Vin = 24Vdc Load: Io = ±0.3A
 Ch 1: Vo1 Ch 2: Vo2

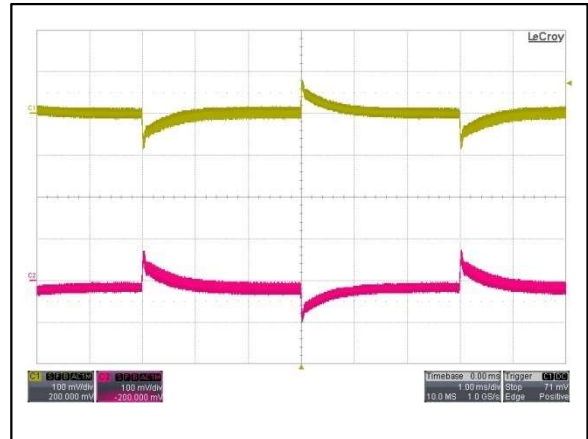

Figure 112: AYA01AA24-L Transient Response
 Vin = 24Vdc Load: Io = 100% to 75% load change
 Ch 1: Vo1 Ch 2: Vo2

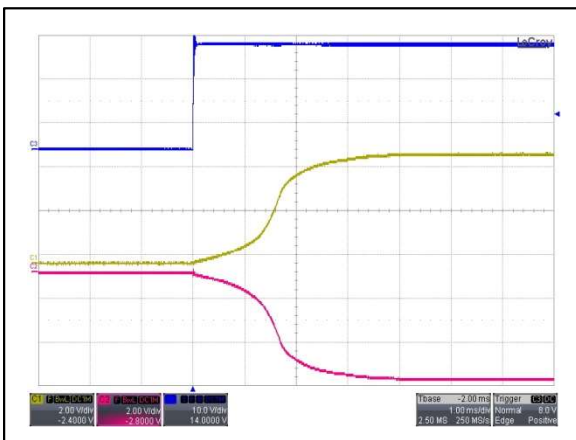

Figure 113: AYA01AA24-L Output Voltage Startup Characteristic by Vin
 Vin = 24Vdc Load: Io = ±0.3A
 Ch 3: Vin Ch 1: Vo1 Ch 2: Vo2

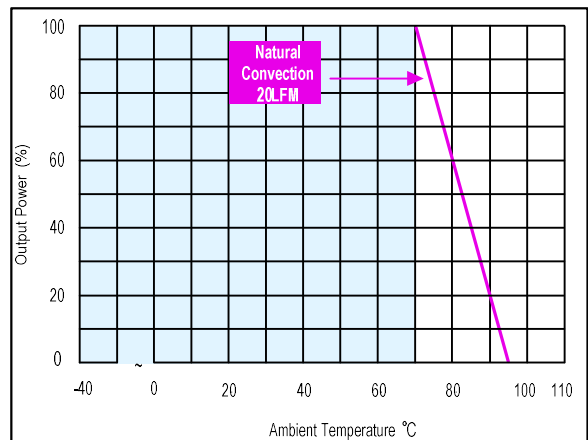

Figure 114: AYA01AA24-L Derating Curve
 Vin = 24Vdc

Electrical Specifications

AYA01BB24-L Performance Curves

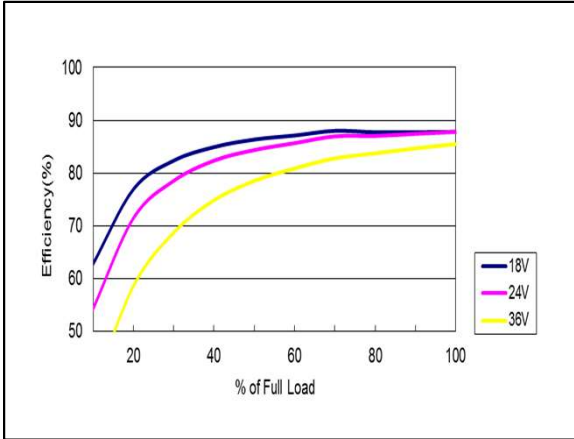

Figure 115: AYA01BB24-L Efficiency Versus Output Current Curve
 Vin = 18 to 36Vdc Load: Io = 0 to ±0.1A

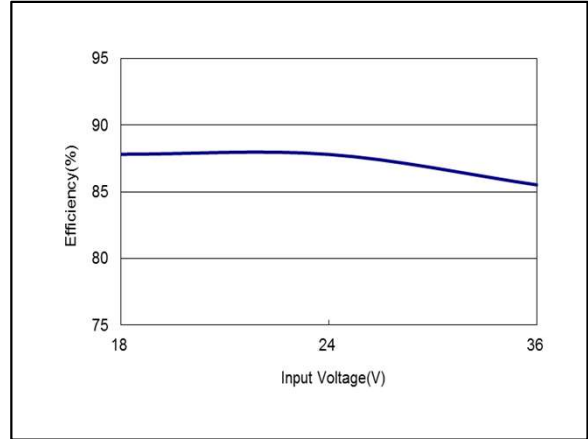

Figure 116: AYA01BB24-L Efficiency Versus Input Voltage Curve
 Vin = 18 to 36Vdc Load: Io = ±0.1A

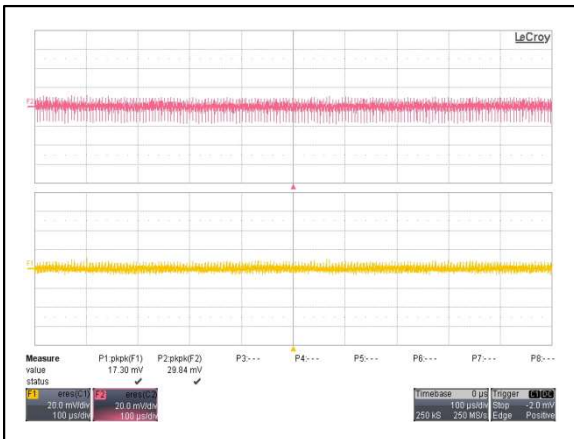

Figure 117: AYA01BB24-L Ripple and Noise Measurement
 Vin = 24Vdc Load: Io = ±0.1A
 Ch 1: Vo1 Ch 2: Vo2

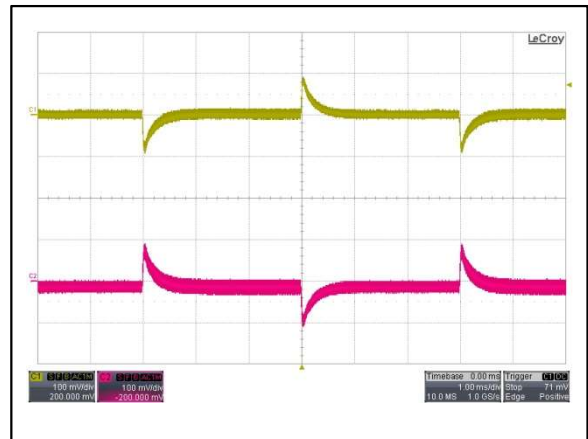

Figure 118: AYA01BB24-L Transient Response
 Vin = 24Vdc Load: Io = 100% to 75% load change
 Ch 1: Vo1 Ch 2: Vo2

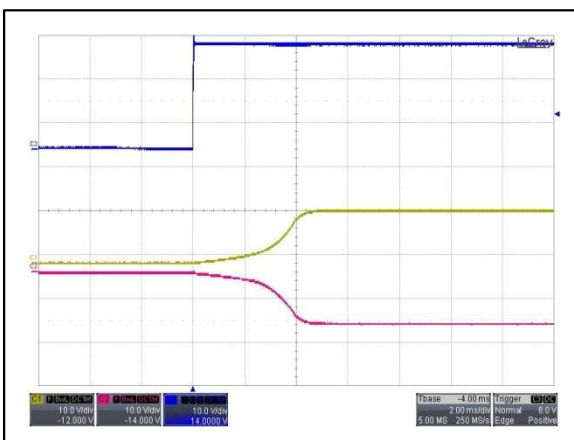

Figure 119: AYA01BB24-L Output Voltage Startup Characteristic by Vin
 Vin = 24Vdc Load: Io = ±0.1A
 Ch 3: Vin Ch 1: Vo1 Ch 2: Vo2

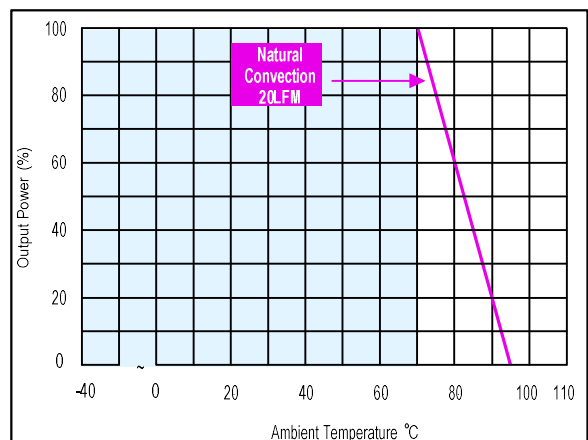

Figure 120: AYA01BB24-L Derating Curve
 Vin = 24Vdc

Electrical Specifications

AYA01CC24-L Performance Curves

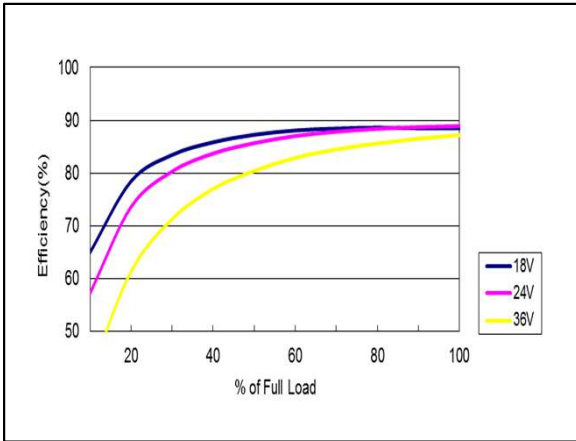

Figure 121: AYA01CC24-L Efficiency Versus Output Current Curve
 Vin = 18 to 36Vdc Load: Io = 0 to ±0.1A

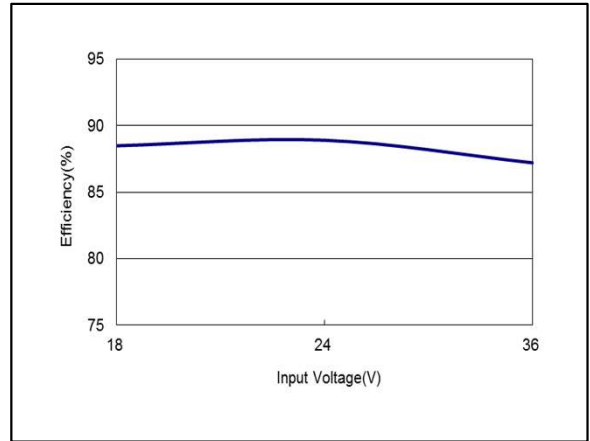

Figure 122: AYA01CC24-L Efficiency Versus Input Voltage Curve
 Vin = 18 to 36Vdc Load: Io = ±0.1A

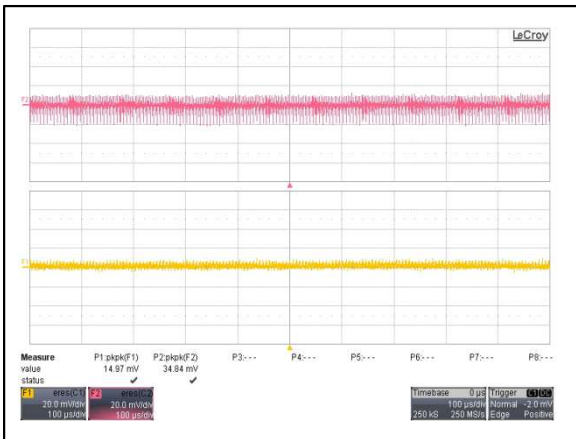

Figure 123: AYA01CC24-L Ripple and Noise Measurement
 Vin = 24Vdc Load: Io = ±0.1A
 Ch 1: Vo1 Ch 2: Vo2

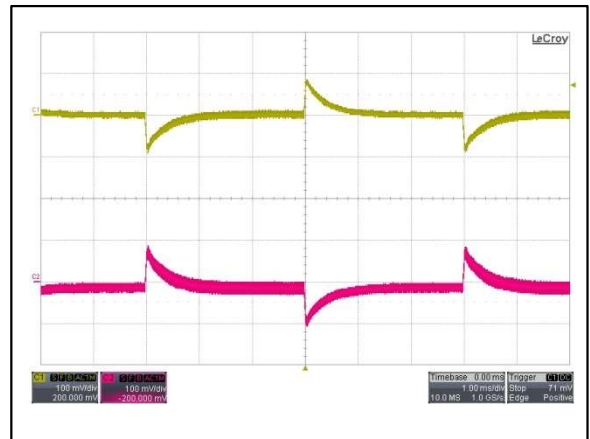

Figure 124: AYA01CC24-L Transient Response
 Vin = 24Vdc Load: Io = 100% to 75% load change
 Ch 1: Vo1 Ch 2: Vo2

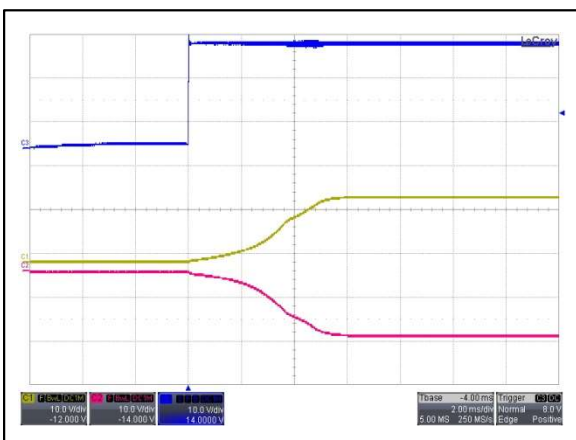

Figure 125: AYA01CC24-L Output Voltage Startup Characteristic by Vin
 Vin = 24Vdc Load: Io = ±0.1A
 Ch 3: Vin Ch 1: Vo1 Ch 2: Vo2

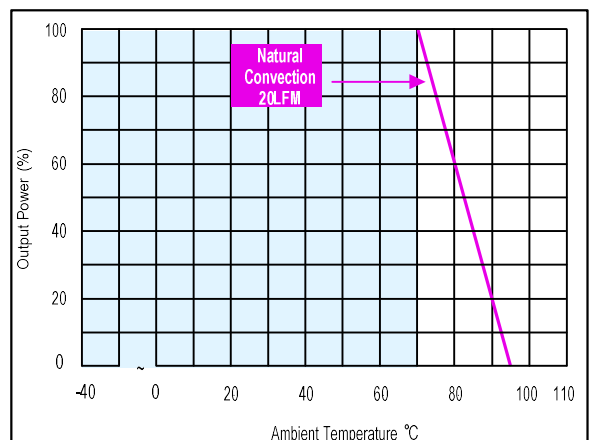

Figure 126: AYA01CC24-L Derating Curve
 Vin = 24Vdc

Electrical Specifications

AYA01F48-L Performance Curves

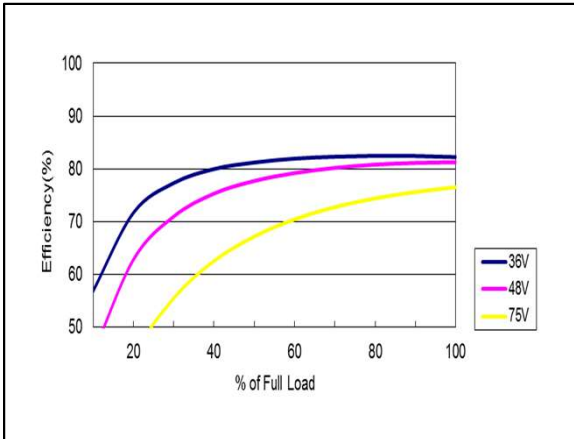

Figure 127: AYA01F48-L Efficiency Versus Output Current Curve
 Vin = 36 to 75Vdc Load: Io = 0 to 0.6A

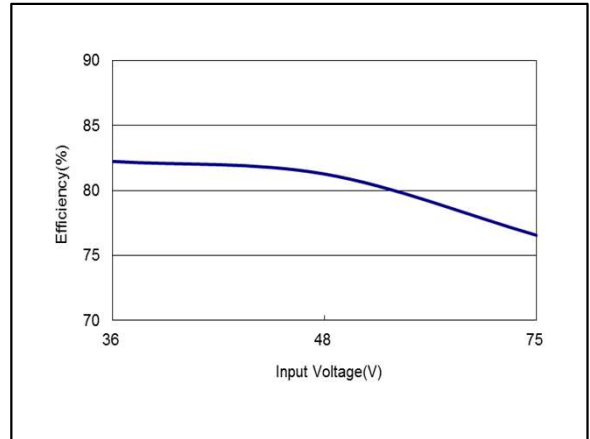

Figure 128: AYA01F48-L Efficiency Versus Input Voltage Curve
 Vin = 36 to 75Vdc Load: Io = 0.6A

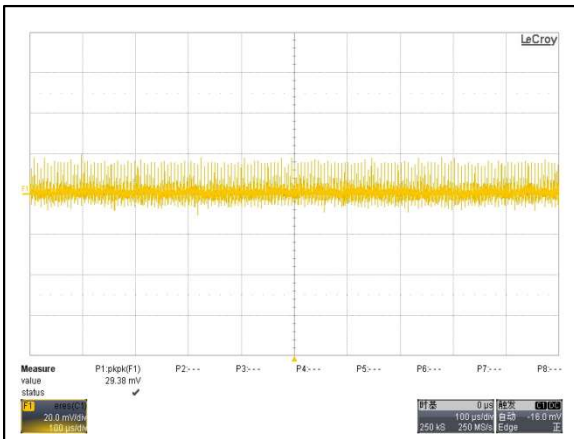

Figure 129: AYA01F48-L Ripple and Noise Measurement
 Vin = 48Vdc Load: Io = 0.6A
 Ch 1: Vo

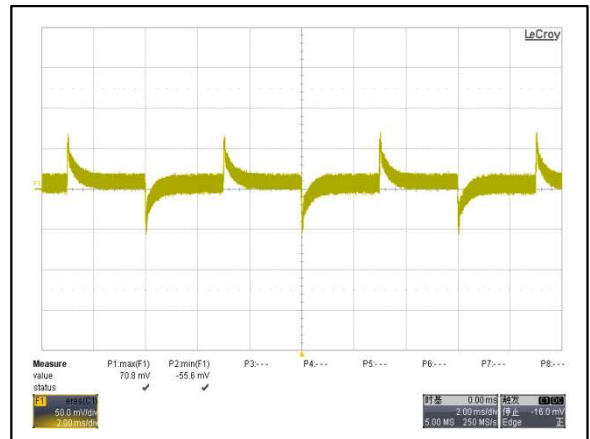

Figure 130: AYA01F48-L Transient Response
 Vin = 48Vdc Load: Io = 100% to 75% load change
 Ch 1: Vo

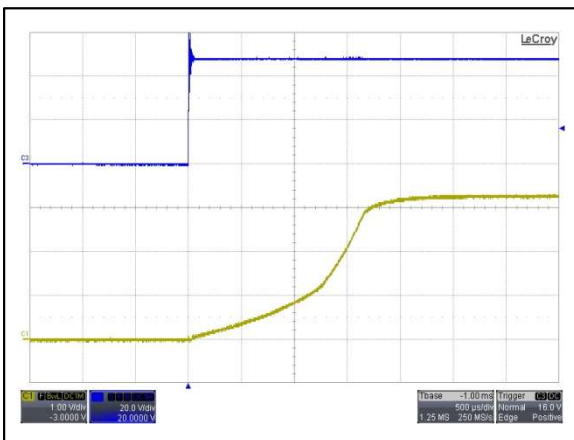

Figure 131: AYA01F48-L Output Voltage Startup Characteristic by Vin
 Vin = 48Vdc Load: Io = 0.6A
 Ch 3: Vin Ch 1: Vo

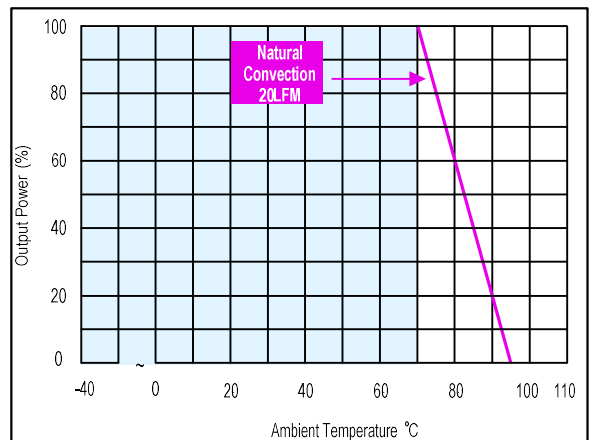

Figure 132: AYA01F48-L Derating Curve
 Vin = 48Vdc

Electrical Specifications

AYA01A48-L Performance Curves

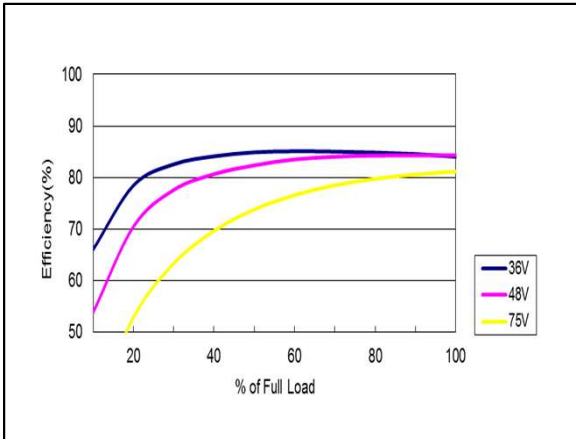

Figure 133: AYA01A48-L Efficiency Versus Output Current Curve
 Vin = 36 to 75Vdc Load: Io = 0 to 0.6A

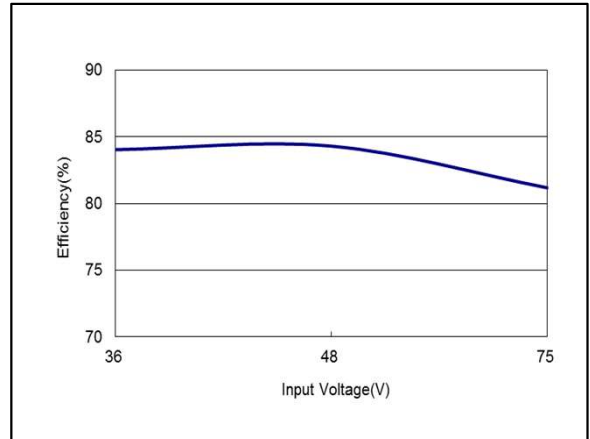

Figure 134: AYA01A48-L Efficiency Versus Input Voltage Curve
 Vin = 36 to 75Vdc Load: Io = 0.6A

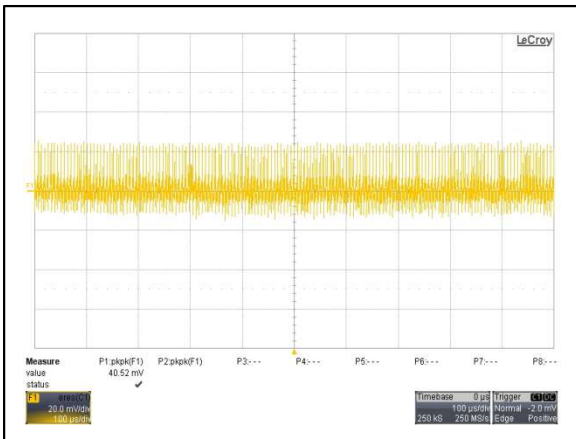

Figure 135: AYA01A48-L Ripple and Noise Measurement
 Vin = 48Vdc Load: Io = 0.6A
 Ch 1: Vo

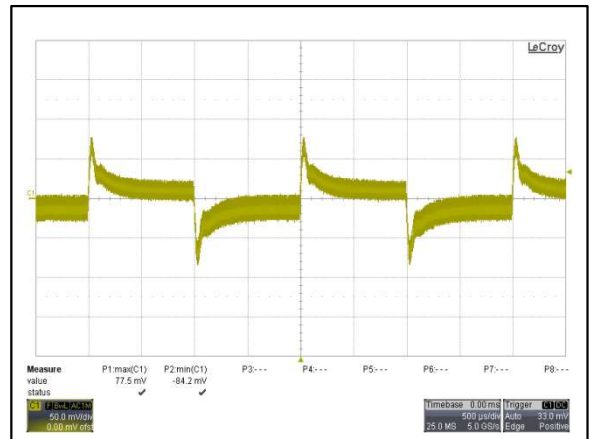

Figure 136: AYA01A48-L Transient Response
 Vin = 48Vdc Load: Io = 100% to 75% load change
 Ch 1: Vo

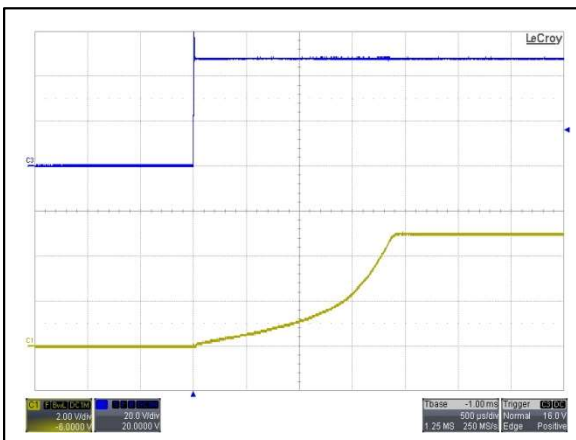

Figure 137: AYA01A48-L Output Voltage Startup Characteristic by Vin
 Vin = 48Vdc Load: Io = 0.6A
 Ch 3: Vin Ch 1: Vo

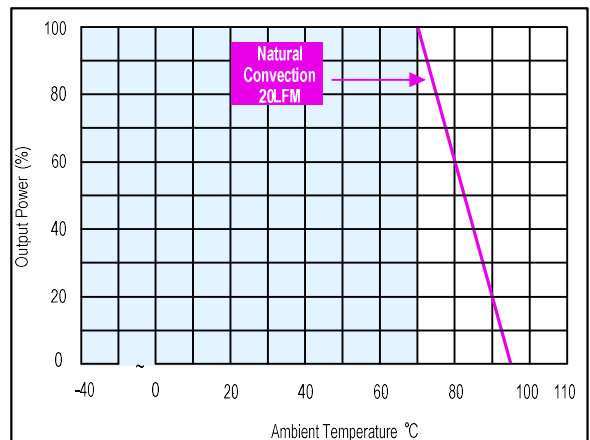

Figure 138: AYA01A48-L Derating Curve
 Vin = 48Vdc

Electrical Specifications

AYA01B48-L Performance Curves

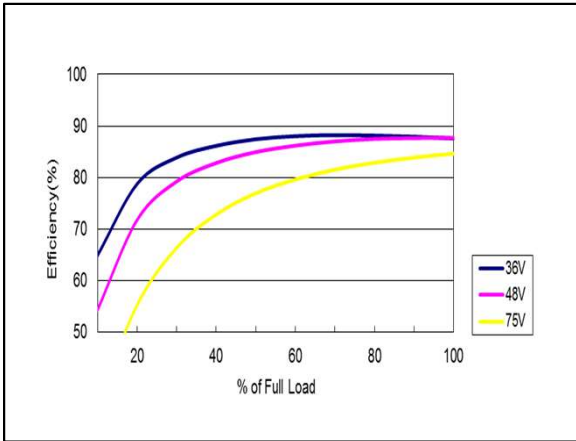

Figure 139: AYA01B48-L Efficiency Versus Output Current Curve
 Vin = 36 to 75Vdc Load: Io = 0 to 0.25A

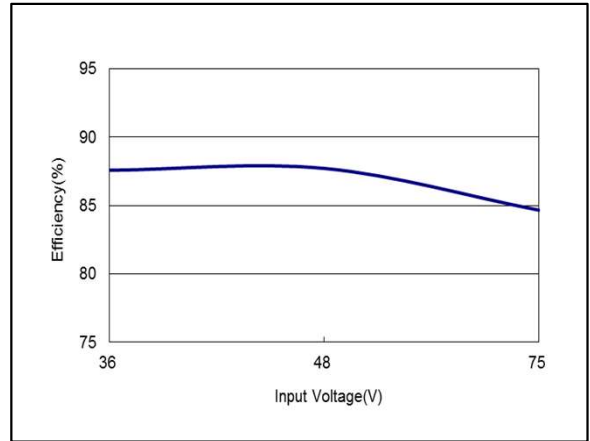

Figure 140: AYA01B48-L Efficiency Versus Input Voltage Curve
 Vin = 36 to 75Vdc Load: Io = 0.25A

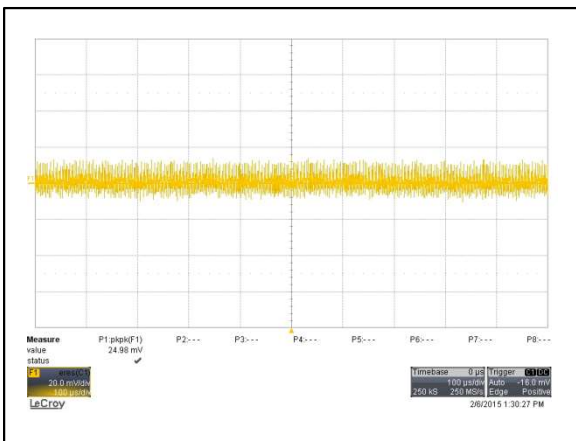

Figure 141: AYA01B48-L Ripple and Noise Measurement
 Vin = 48Vdc Load: Io = 0.25A
 Ch 1: Vo

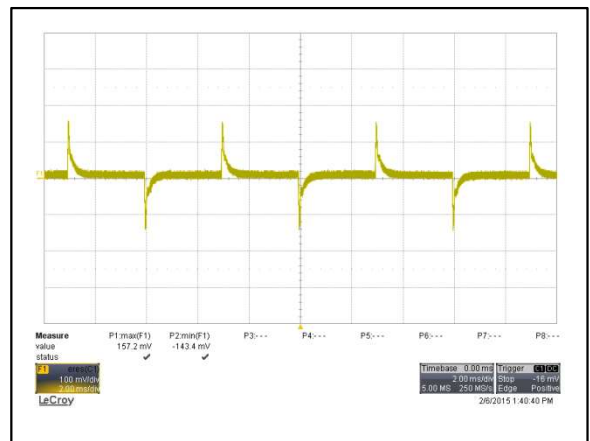

Figure 142: AYA01B48-L Transient Response
 Vin = 48Vdc Load: Io = 100% to 75% load change
 Ch 1: Vo

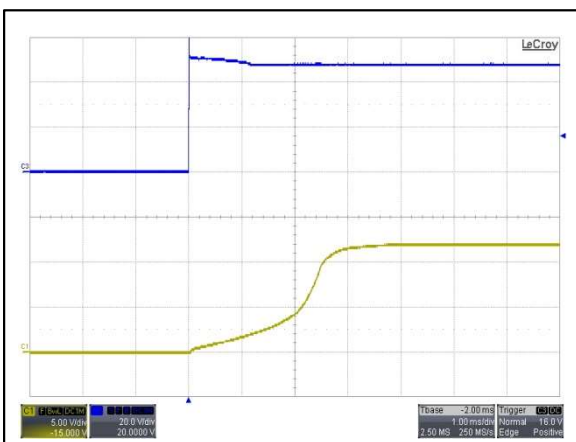

Figure 143: AYA01B48-L Output Voltage Startup Characteristic by Vin
 Vin = 48Vdc Load: Io = 0.25A
 Ch 3: Vin Ch 1: Vo

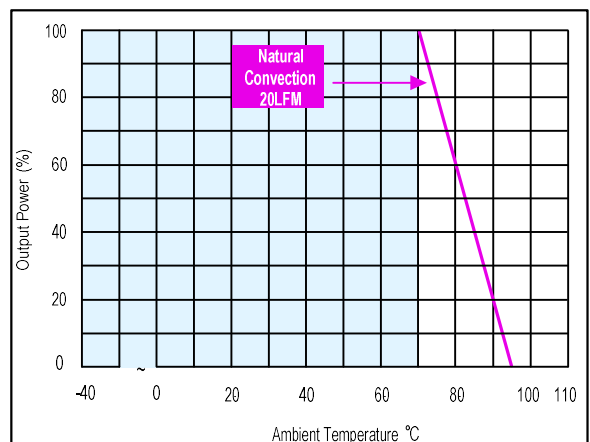

Figure 144: AYA01B48-L Derating Curve
 Vin = 48Vdc

Electrical Specifications

AYA01C48-L Performance Curves

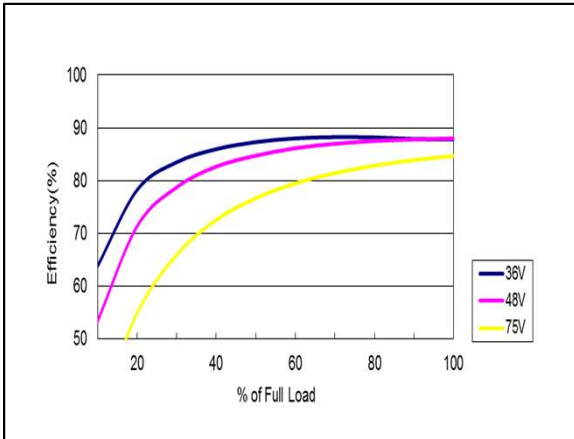

Figure 145: AYA01C48-L Efficiency Versus Output Current Curve
 Vin = 36 to 75Vdc Load: Io = 0 to 0.2A

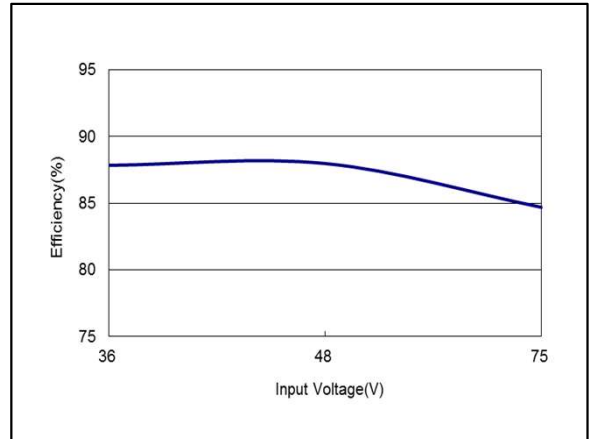

Figure 146: AYA01C48-L Efficiency Versus Input Voltage Curve
 Vin = 36 to 75Vdc Load: Io = 0.2A

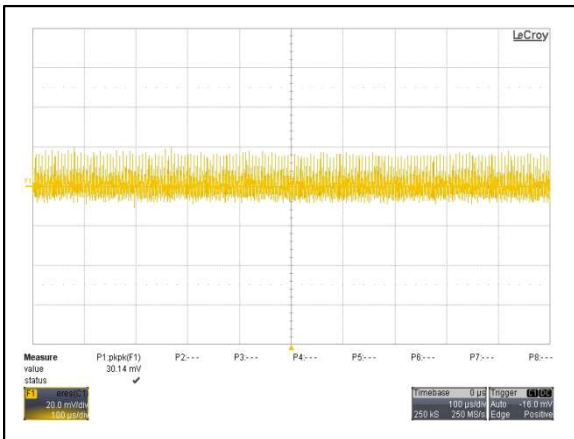

Figure 147: AYA01C48-L Ripple and Noise Measurement
 Vin = 48Vdc Load: Io = 0.2A
 Ch 1: Vo

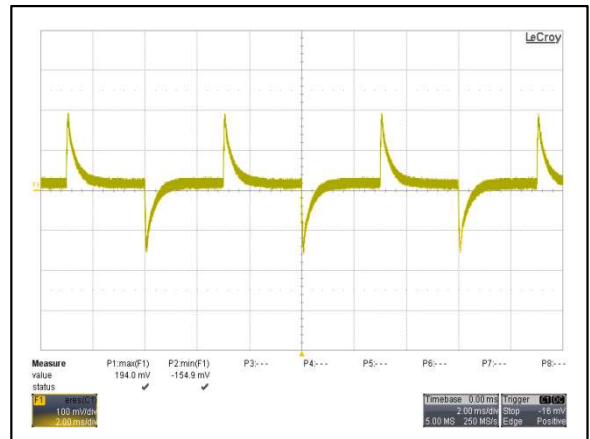

Figure 148: AYA01C48-L Transient Response
 Vin = 48Vdc Load: Io = 100% to 75% load change
 Ch 1: Vo

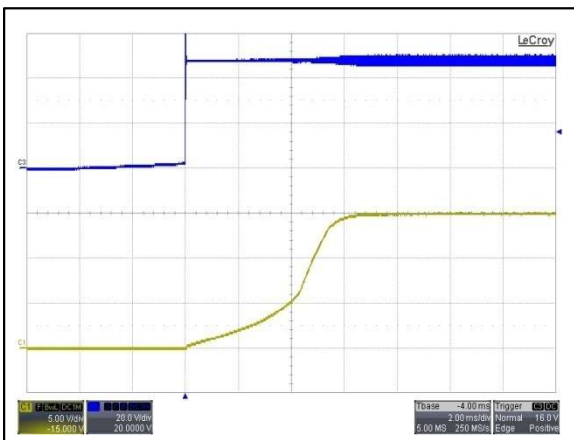

Figure 149: AYA01C48-L Output Voltage Startup Characteristic by Vin
 Vin = 48Vdc Load: Io = 0.2A
 Ch 3: Vin Ch 1: Vo

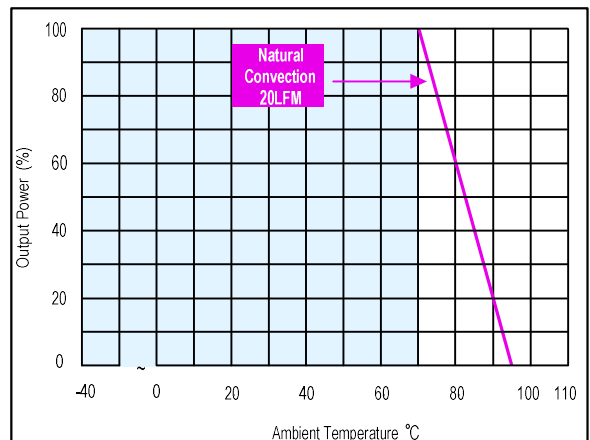

Figure 150: AYA01C48-L Derating Curve
 Vin = 48Vdc

Electrical Specifications

AYA01AA48-L Performance Curves

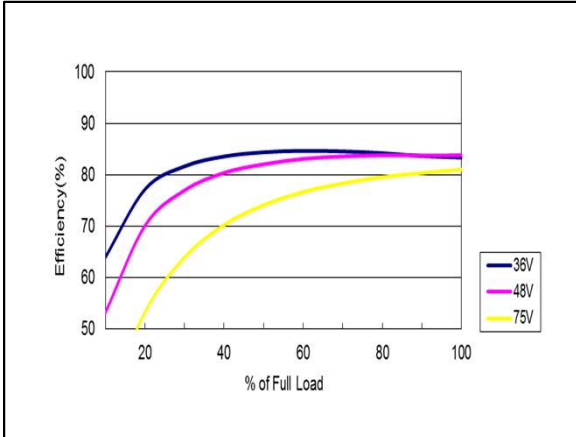

Figure 151: AYA01AA48-L Efficiency Versus Output Current Curve
 Vin = 36 to 75Vdc Load: $I_o = 0$ to $\pm 0.3A$

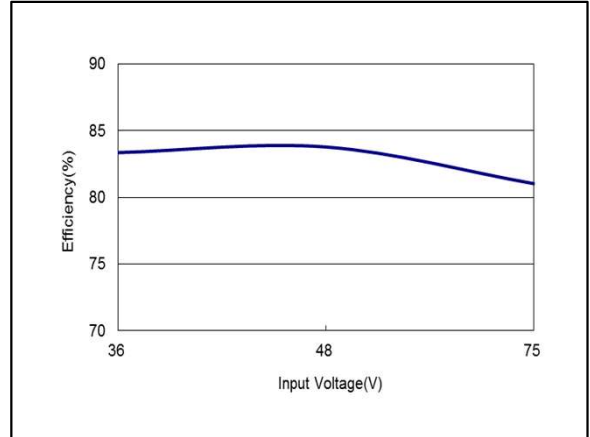

Figure 152: AYA01AA48-L Efficiency Versus Input Voltage Curve
 Vin = 36 to 75Vdc Load: $I_o = \pm 0.3A$

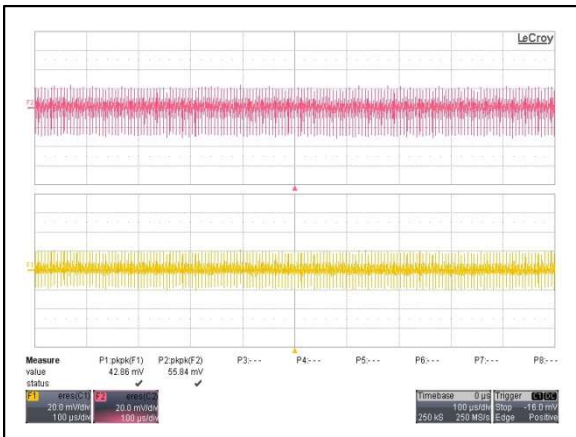

Figure 153: AYA01AA48-L Ripple and Noise Measurement
 Vin = 48Vdc Load: $I_o = \pm 0.3A$
 Ch 1: Vo

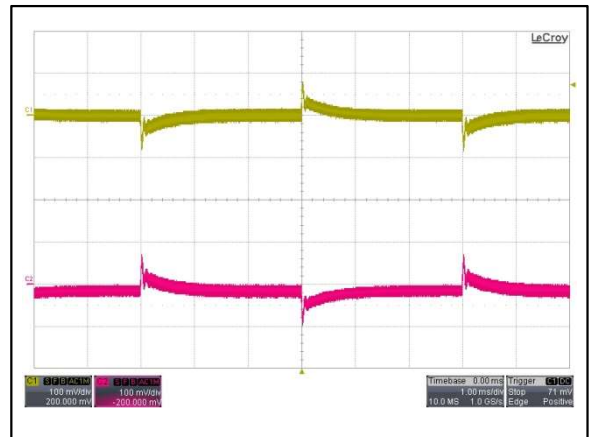

Figure 154: AYA01AA48-L Transient Response
 Vin = 48Vdc Load: $I_o = 100\%$ to 75% load change
 Ch 1: Vo1 Ch 2: Vo2

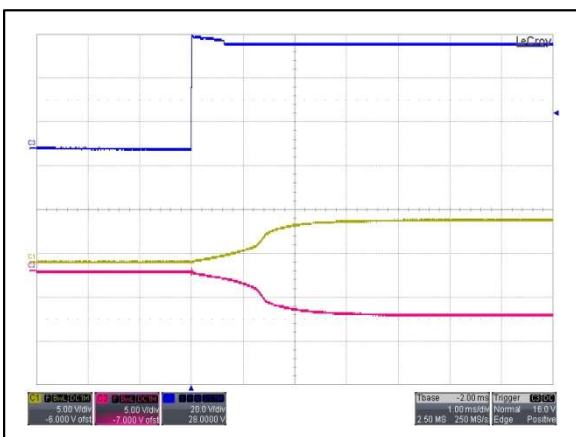

Figure 155: AYA01AA48-L Output Voltage Startup Characteristic by Vin
 Vin = 48Vdc Load: $I_o = \pm 0.3A$
 Ch 3: Vin Ch 1: Vo1 Ch 2: Vo2

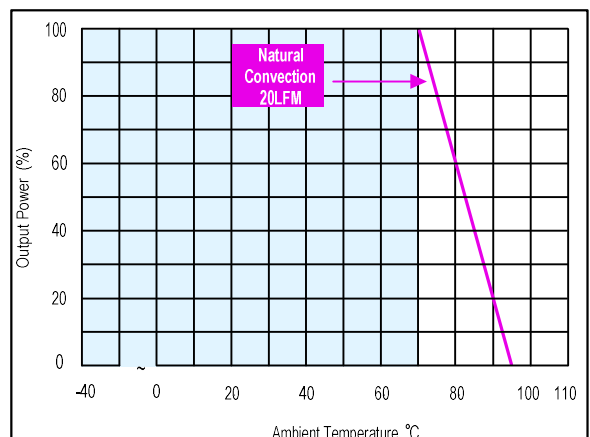

Figure 156: AYA01AA48-L Derating Curve
 Vin = 48Vdc

Electrical Specifications

AYA01BB48-L Performance Curves

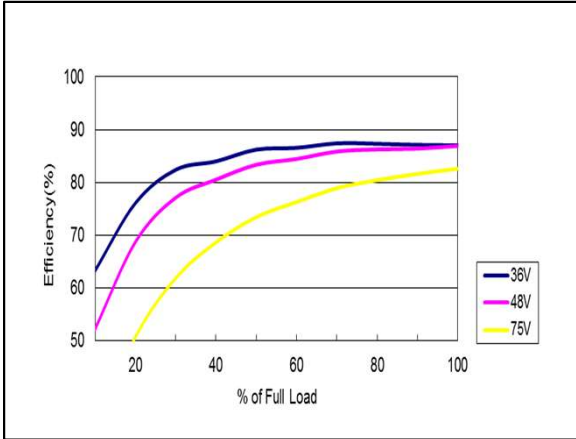

Figure 157: AYA01BB48-L Efficiency Versus Output Current Curve
 Vin = 36 to 75Vdc Load: $I_o = 0$ to $\pm 0.125A$

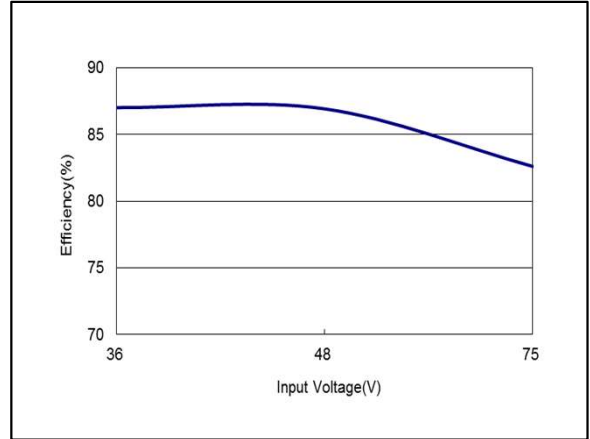

Figure 158: AYA01BB48-L Efficiency Versus Input Voltage Curve
 Vin = 36 to 75Vdc Load: $I_o = \pm 0.125A$

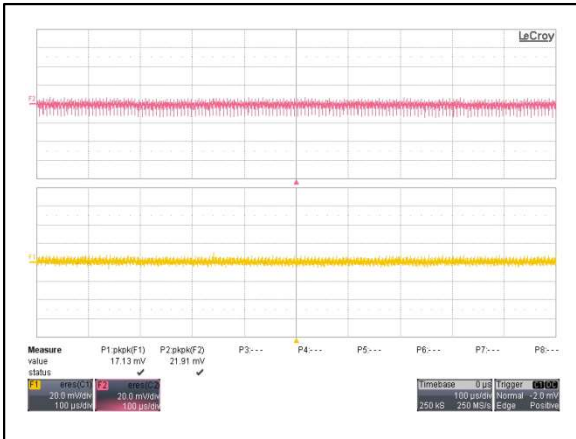

Figure 159: AYA01BB48-L Ripple and Noise Measurement
 Vin = 48Vdc Load: $I_o = \pm 0.125A$
 Ch 1: Vo

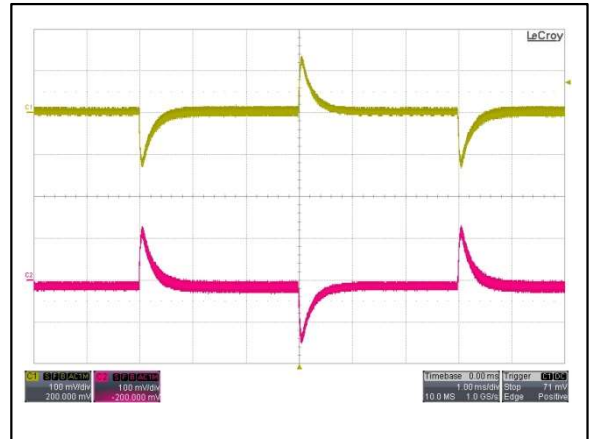

Figure 160: AYA01BB48-L Transient Response
 Vin = 48Vdc Load: $I_o = 100\%$ to 75% load change
 Ch 1: Vo1 Ch 2: Vo2

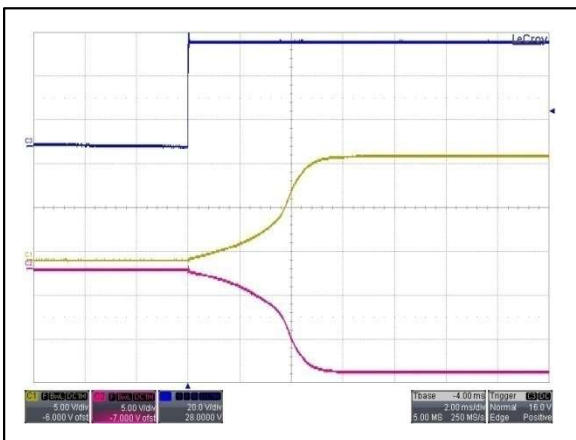

Figure 161: AYA01BB48-L Output Voltage Startup Characteristic by Vin
 Vin = 48Vdc Load: $I_o = \pm 0.125A$
 Ch 3: Vin Ch 1: Vo1 Ch 2: Vo2

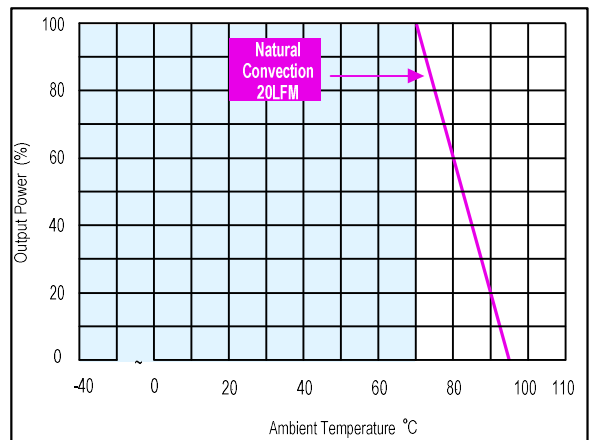

Figure 162: AYA01BB48-L Derating Curve
 Vin = 48Vdc

Electrical Specifications

AYA01CC48-L Performance Curves

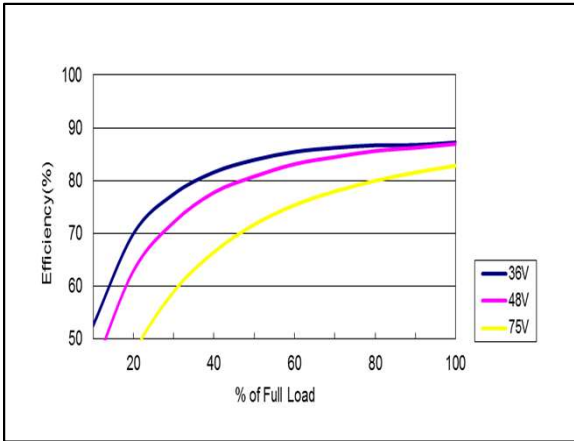

Figure 163: AYA01CC48-L Efficiency Versus Output Current Curve
 Vin = 36 to 75Vdc Load: $I_o = 0$ to $\pm 0.1A$

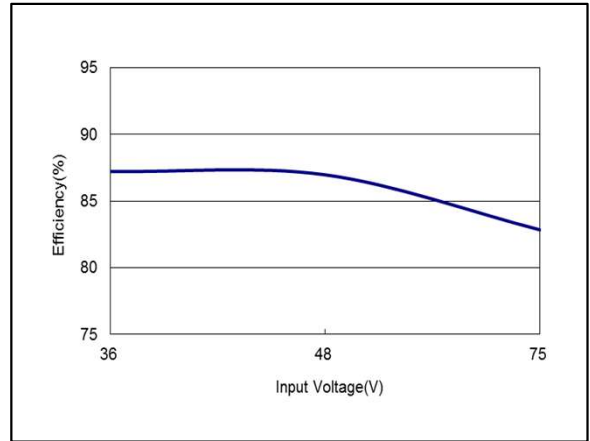

Figure 164: AYA01CC48-L Efficiency Versus Input Voltage Curve
 Vin = 36 to 75Vdc Load: $I_o = \pm 0.1A$

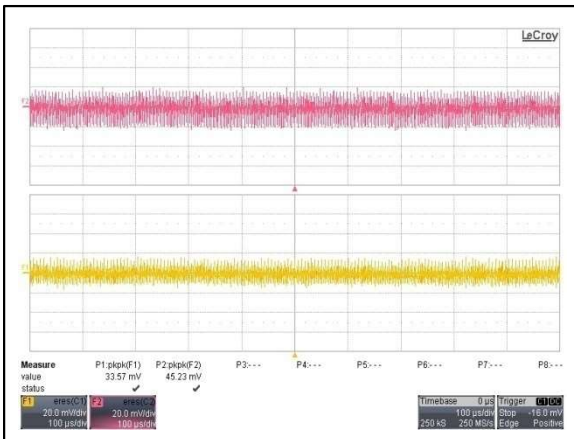

Figure 165: AYA01CC48-L Ripple and Noise Measurement
 Vin = 48Vdc Load: $I_o = \pm 0.1A$
 Ch 1: Vo

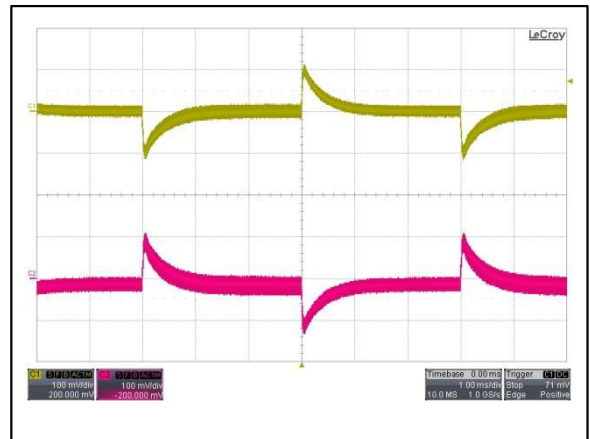

Figure 166: AYA01CC48-L Transient Response
 Vin = 48Vdc Load: $I_o = 100\%$ to 75% load change
 Ch 1: Vo1 Ch 2: Vo2

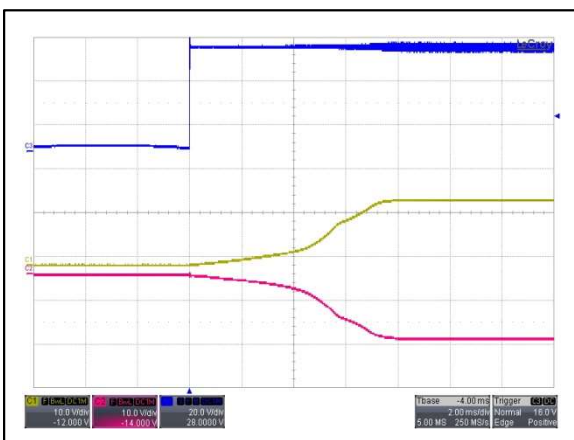

Figure 167: AYA01CC48-L Output Voltage Startup Characteristic by Vin
 Vin = 48Vdc Load: $I_o = \pm 0.1A$
 Ch 3: Vin Ch 1: Vo1 Ch 2: Vo2

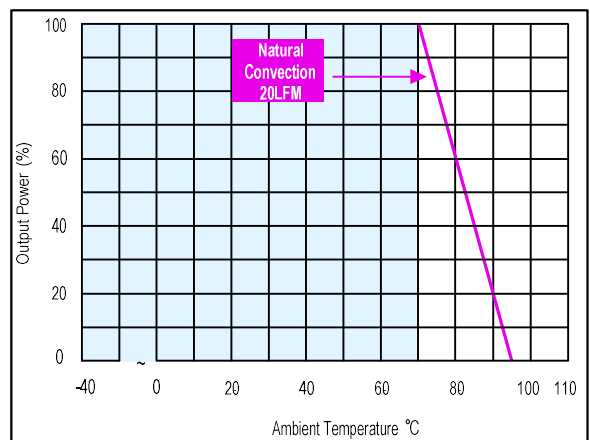
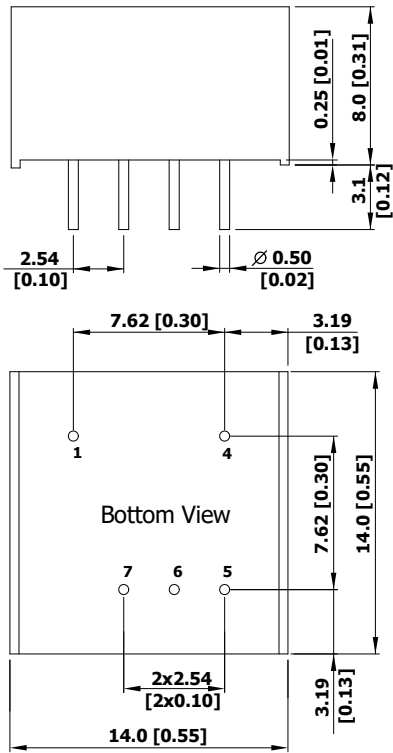

Figure 168: AYA01CC48-L Derating Curve
 Vin = 48Vdc

Mechanical Specifications

Mechanical Outlines (unit: mm)



Note:

- 1.All dimensions in mm (inches)
- 2.Tolerance: X.X±0.5 (X.XX±0.02)
X.XX±0.25 (X.XXX±0.01)
- 3.Pin diameter 0.5 ±0.05 (0.02±0.0002)

Pin Connections

Single output

- Pin 1 - -Vin
- Pin 4 - +Vin
- Pin 5 - +Vout
- Pin 6 - No Pin
- Pin 7 - -Vout

Dual Output

- Pin 1 - -Vin
- Pin 4 - +Vin
- Pin 5 - +Vout
- Pin 6 - Common
- Pin 7 - -Vout

Physical Characteristics

Device code suffix	Characteristics
Case Size	14.0 x 14.0 x 8.0mm (0.55x0.55x0.31 inches)
Case Material	Non-Conductive Black Plastic (Flammability to UL 94V-0 rated)
Pin Material	Tinned Copper
Weight	3.9g

Mechanical Specifications

Recommended Pad Layout for Single & Dual Output Converter

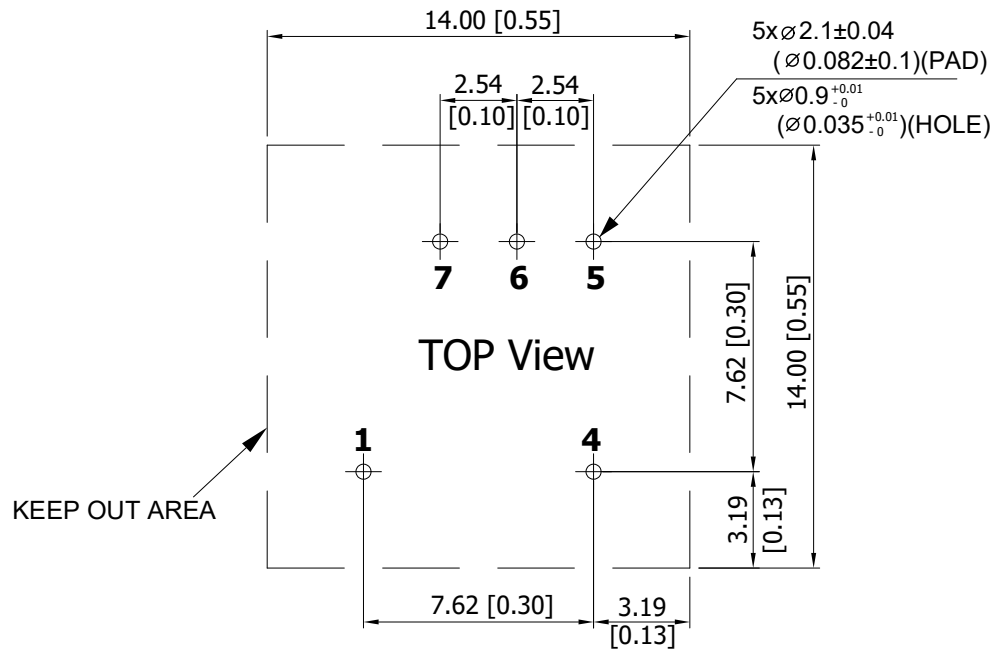

Note:
All dimensions in mm (inches)

Mechanical Specifications

Weight

The typical weight of AYA 3W series converters is 3.9g.

Environmental Specifications

EMC Immunity

AYA 3W series power supply is designed to meet the following EMC immunity specifications.

Table 4. EMC Specifications		
Parameter	Standards & Level	Performance
EMI	EN55022, FCC part 15	Class A & Class B
ESD	EN61000-4-2 Air \pm 8KV , Contact \pm 6KV	A
Radiated Immunity	EN61000-4-3 10V/M	A
Fast transient	EN61000-4-4 \pm 2KV	A
Surge	EN61000-4-5 \pm 1KV	A
Conducted Immunity	EN61000-4-6 10Vrms	A

Environmental Specifications

EMC Considerations

External filter meets EN 55022, class A, class B, FCC part 15, level A, level B

Conducted and radiated emissions EN55022 Class B

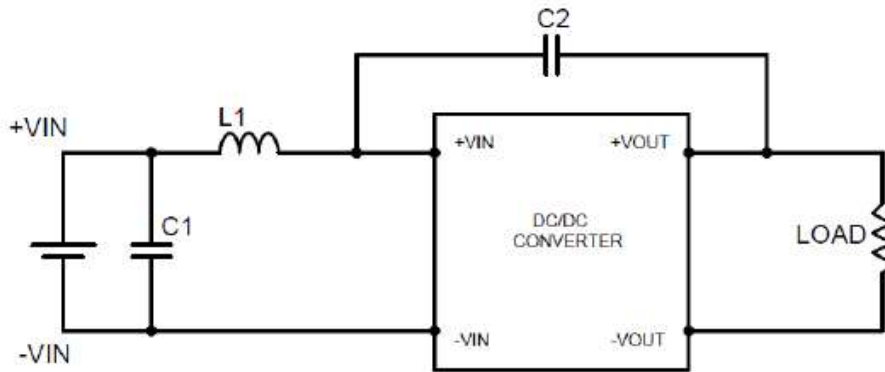

Table 5. Class A specifications		
Model	Component	Value
AYA01F05-L AYA01A05-L AYA01B05-L AYA01C05-L AYA01AA05-L AYA01BB05-L AYA01CC05-L	C1	22μF/16V
	C2	None
	L1	3.3μH/4A
AYA01F12-L AYA01A12-L AYA01B12-L AYA01C12-L AYA01AA12-L AYA01BB12-L AYA01CC12-L	C1	22μF/25V
	C2	None
	L1	18μH/1.45A
AYA01F24-L AYA01A24-L AYA01B24-L AYA01C24-L AYA01AA24-L AYA01BB24-L AYA01CC24-L	C1	10μF/50V
	C2	None
	L1	39μH/0.94A
AYA01F48-L AYA01A48-L AYA01B48-L AYA01C48-L AYA01AA48-L AYA01BB48-L AYA01CC48-L	C1	3.3μF/100V
	C2	None
	L1	68μH/0.64A

Environmental Specifications

EMC Considerations con't

Table 6. Class B specifications		
Model	Component	Value
AYA01F05-L AYA01A05-L AYA01B05-L AYA01C05-L AYA01AA05-L AYA01BB05-L AYA01CC05-L	C1	22µF/16V
	C2	None
	L1	10µH/2.2A
AYA01F12-L AYA01A12-L AYA01B12-L AYA01C12-L AYA01AA12-L AYA01BB12-L AYA01CC12-L	C1	22µF/25V
	C2	220pF/2KV
	L1	18µH/1.45A
AYA01F24-L AYA01A24-L AYA01B24-L AYA01C24-L AYA01AA24-L AYA01BB24-L AYA01CC24-L	C1	10µF/50V
	C2	220pF/2KV
	L1	68µH/0.64A
AYA01F48-L AYA01A48-L AYA01B48-L AYA01C48-L AYA01AA48-L AYA01BB48-L AYA01CC48-L	C1	4.7µF/100V
	C2	220pF/2KV
	L1	82µH/0.6A

Environmental Specifications

Safety Certifications

The AYA 3W power supply is intended for inclusion in other equipment and the installer must ensure that it is in compliance with all the requirements of the end application. This product is only for inclusion by professional installers within other equipment and must not be operated as a stand alone product.

Table 7. Safety Certifications for AYA series power supply system	
Document	Description
cUL/UL 60950-1 (UL certificate)	US and Canada Requirements
IEC/EN 60950-1 (CB-scheme)	European Requirements

Environmental Specifications

MTBF and Reliability

The MTBF of AYA 3W series of DC/DC converters has been calculated using MIL-HDBK 217F NOTICE2, Operating Temperature 25 °C, Ground Benign.

Model	MTBF	Unit
AYA01F05-L	3,471,000	Hours
AYA01A05-L	3,294,000	
AYA01B05-L	4,221,000	
AYA01C05-L	4,763,000	
AYA01AA05-L	3,258,000	
AYA01BB05-L	4,437,000	
AYA01CC05-L	4,273,000	
AYA01F12-L	3,595,000	
AYA01A12-L	3,593,000	
AYA01B12-L	4,601,000	
AYA01C12-L	4,316,000	
AYA01AA12-L	3,509,000	
AYA01BB12-L	4,530,000	
AYA01CC12-L	4,612,000	
AYA01F24-L	3,530,000	
AYA01A24-L	3,516,000	
AYA01B24-L	4,584,000	
AYA01C24-L	4,584,000	
AYA01AA24-L	3,493,000	
AYA01BB24-L	4,725,000	
AYA01CC24-L	4,552,000	
AYA01F48-L	3,736,000	
AYA01A48-L	3,450,000	
AYA01B48-L	4,480,000	
AYA01C48-L	4,480,000	
AYA01AA48-L	3,310,000	
AYA01BB48-L	3,706,000	
AYA01CC48-L	4,296,000	

Application Notes

Input Source Impedance

The power module should be connected to a low ac-impedance input source. Highly inductive source impedances can affect the stability of the power module.

In applications where power is supplied over long lines and output loading is high, it may be necessary to use a capacitor at the input to ensure startup.

Capacitor mounted close to the power module helps ensure stability of the unit, it is recommended to use a good quality low Equivalent Series Resistance (ESR < 1.0Ω at 100 KHz) capacitor of a 8.2μF for the 5V input devices, a 3.3uF for 12V input devices and a 1.5uF for the 24V and 48V input devices.

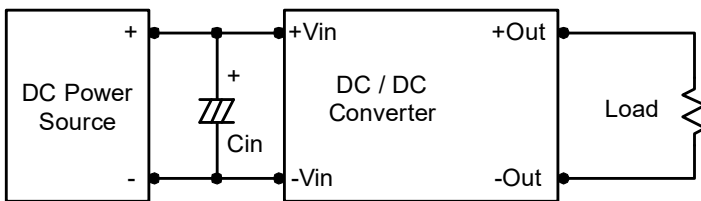

Application Notes

Output Ripple Reduction

A good quality low ESR capacitor placed as close as practicable across the load will give the best ripple and noise performance. To reduce output ripple, it is recommended to use 3.3uF capacitors at the output.

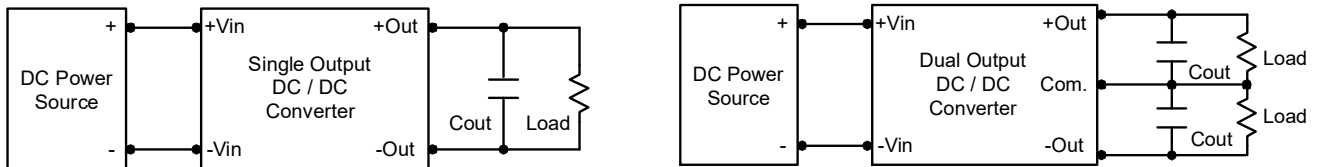

Peak-to-Peak Output Noise Measurement Test

Use a 1uF ceramic capacitor and a 10uF tantalum capacitor. Scope measurement should be made by using a BNC socket, measurement bandwidth is 0-20MHz. Position the load between 50 mm and 75 mm from the DC/DC Converter.

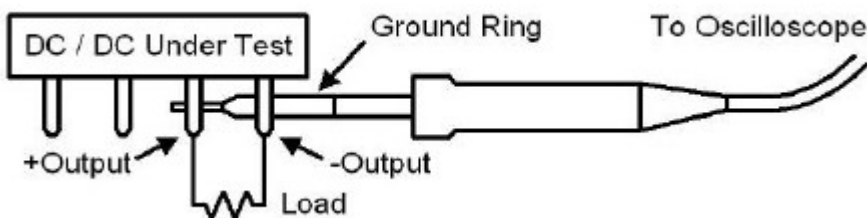
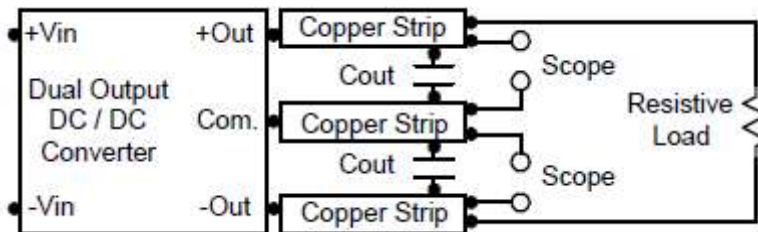
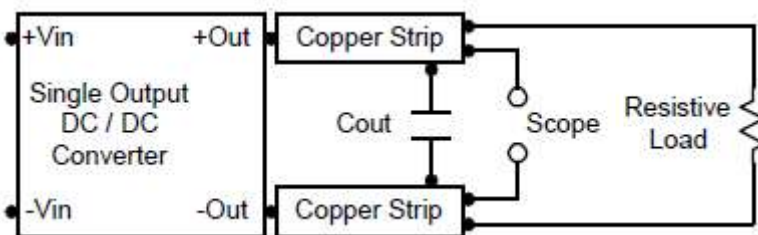

Application Notes

Overcurrent Protection

The AYA 3W series converters contain foldback mode output over current protection that prevents damaging to the product in the event of an overload or a short circuit. Normally, over current is maintained at approximately 170 percent of rated current for AYA 3W series.

When the load attempts to draw over current from the supply, foldback reduces both the output voltage and current to well below the normal operating limits. Under a short circuit, where the output voltage has reduced to zero, the current is typically limited to a small fraction of the maximum current.

The output current waveform with foldback over current protection is shown in figure below.

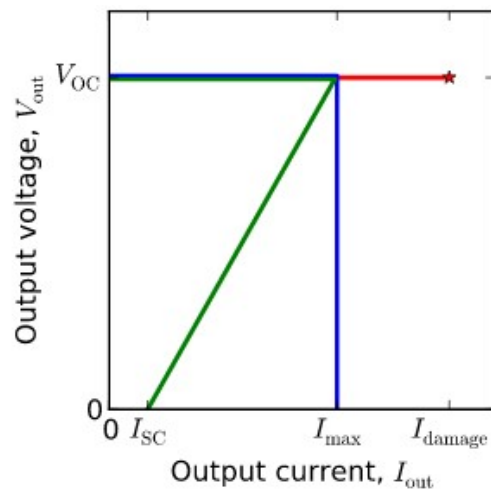

Short Circuitry Protection

Continuous and auto-recovery mode.

During short circuit, converter still shut down. The average current during this condition is very low and the device is safe in this condition.

Application Notes

Thermal Considerations

Many conditions affect the thermal performance of the power module, such as orientation, airflow over the module and board spacing. To avoid exceeding the maximum temperature rating of the components inside the power module, the case temperature must be kept below 105°C. The derating curves are determined from measurements obtained in a test setup.

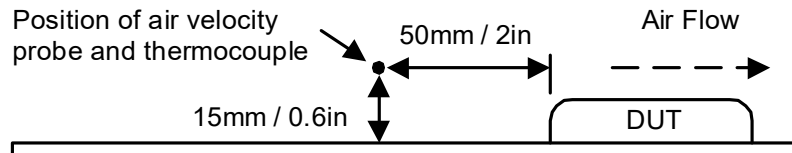

Maximum Capacitive Load

The AYA 3W series converters have a limitation of maximum connected capacitance at the output. The power module may be operated in current limiting mode during start-up, affecting the ramp-up and the startup time. The maximum capacitance can be found in the datasheet.

Application Notes

Switching Frequency

The different units have different switching frequency. The switching frequency is chosen after consideration of size, power, efficiency, component-design are taken in to consideration.

Below is an example about the relationship of switching frequency, input voltage and load.

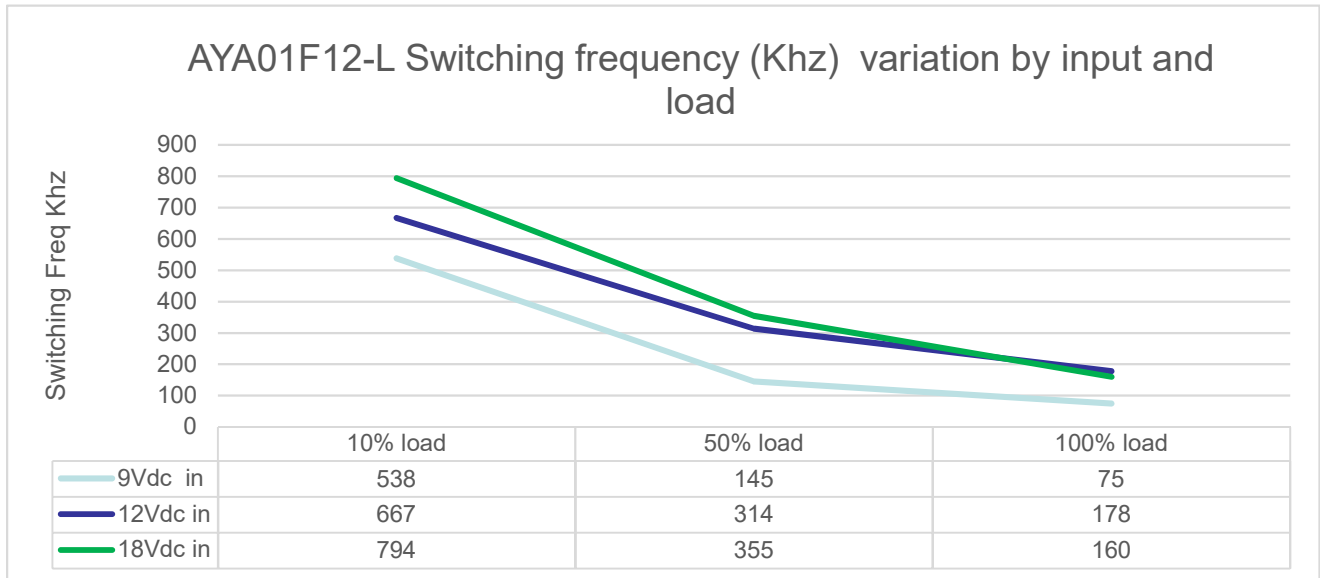

Figure 169. AYA01F12-L Switching Frequency

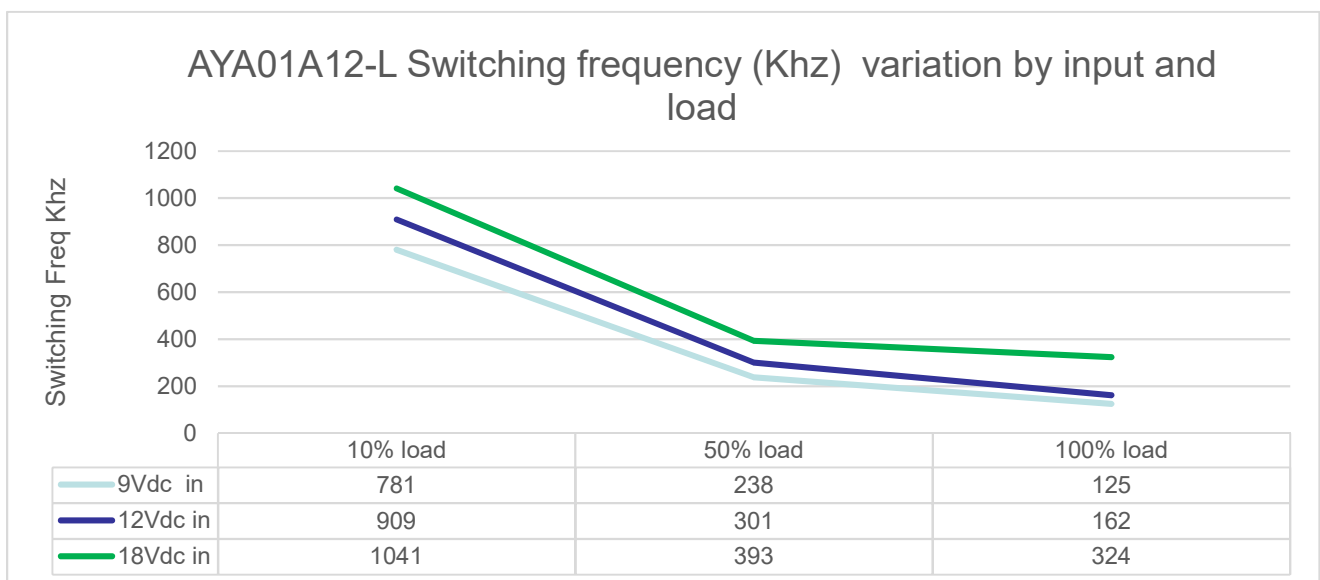

Figure 170. AYA01A12-L Switching Frequency

Application Notes

Switching Frequency con't

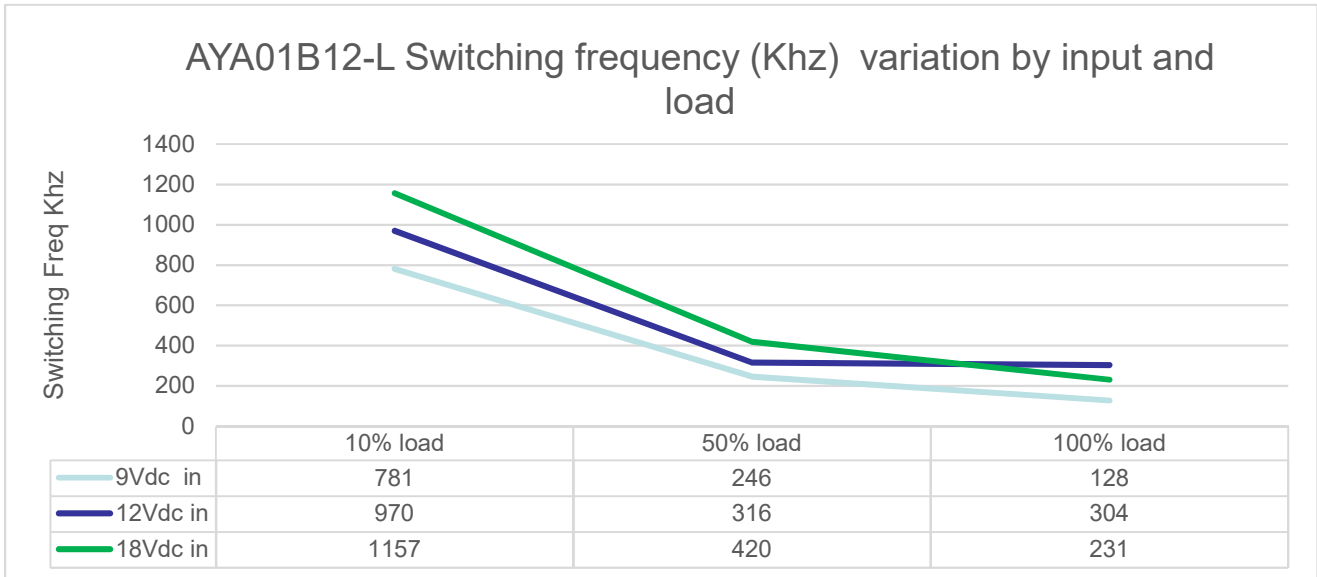
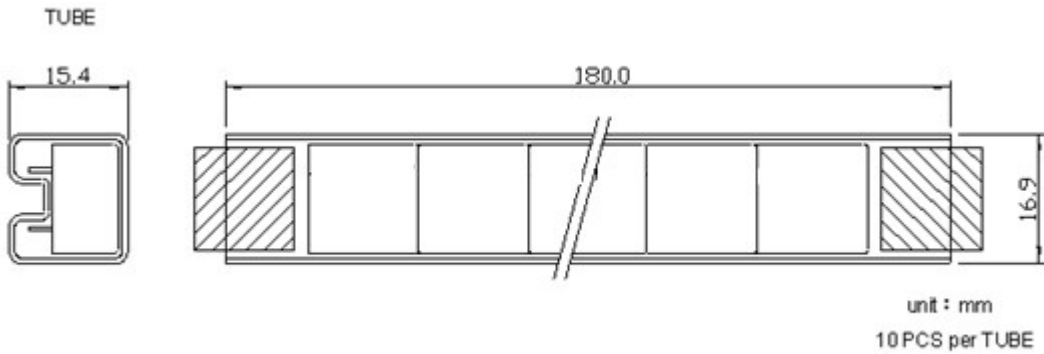

Figure 171. AYA01B12-L Switching Frequency

Application Notes

Packaging Information



Soldering and Reflow Considerations

Lead free wave solder profile for AYA 3W Series

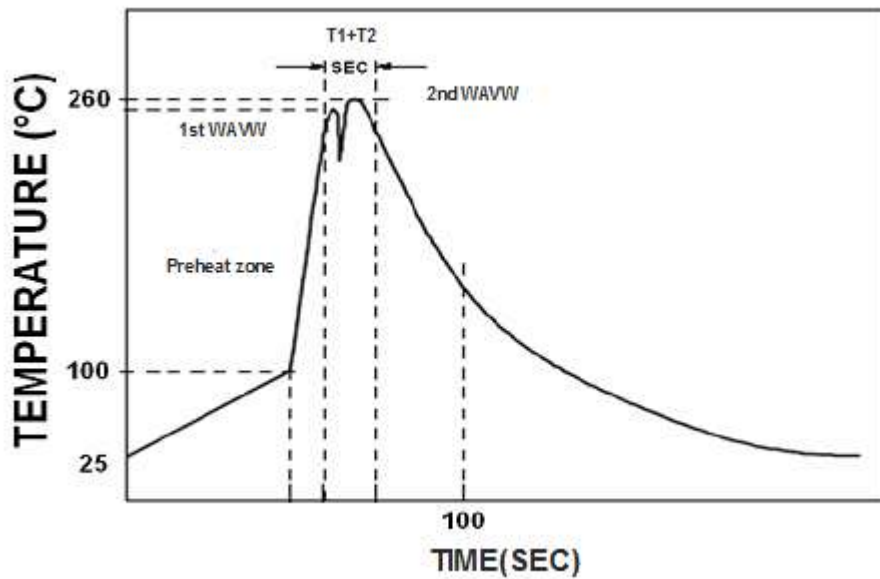

Zone	Reference Parameter
Preheat zone	Rise temp speed : 3°C/sec max.
	Preheat temp : 100~130°C
Actual heating	Peak temp: 250~260°C Peak Time
	Peak time(T1+T2): 4~6 sec

Reference Solder: Sn-Ag-Cu : Sn-Cu : Sn-Ag
 Hand Welding: Soldering iron : Power 60W
 Welding Time: 2~4 sec
 Temp.: 380~400 °C

Record of Revision and Changes

Issue	Date	Description	Originators
1.0	09.23.2016	First Issue	Leo.L
1.1	12.18.2017	Update the Switching Frequency	Leo.L
1.2	05.11.2022	Update format issue and typo	K. Wang



For international contact information,
visit advancedenergy.com.

powersales@aei.com (Sales Support)
productsupport.ep@aei.com (Technical Support)
+1 888 412 7832

ABOUT ADVANCED ENERGY

Advanced Energy (AE) has devoted more than three decades to perfecting power for its global customers. AE designs and manufactures highly engineered, precision power conversion, measurement and control solutions for mission-critical applications and processes.

Our products enable customer innovation in complex applications for a wide range of industries including semiconductor equipment, industrial, manufacturing, telecommunications, data center computing, and medical. With deep applications know-how and responsive service and support across the globe, we build collaborative partnerships to meet rapid technological developments, propel growth for our customers, and innovate the future of power.

PRECISION | POWER | PERFORMANCE

Specifications are subject to change without notice. Not responsible for errors or omissions. ©2020 Advanced Energy Industries, Inc. All rights reserved. Advanced Energy®, and AE® are U.S. trademarks of Advanced Energy Industries, Inc.